

TECHNICAL DATA



600.316.1



600.316.4



600.316.6

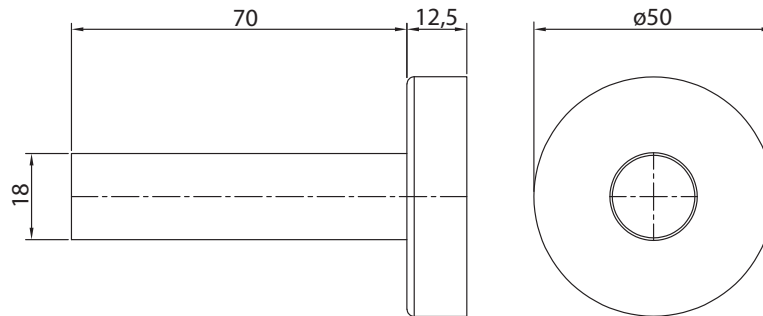

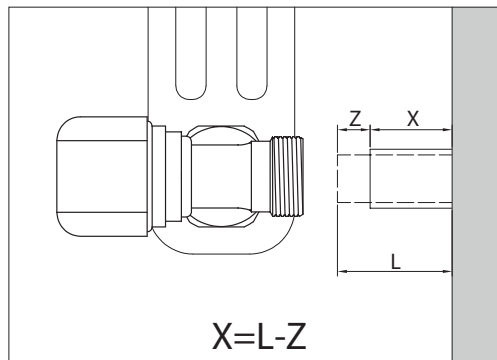
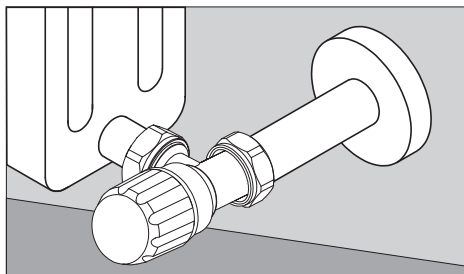
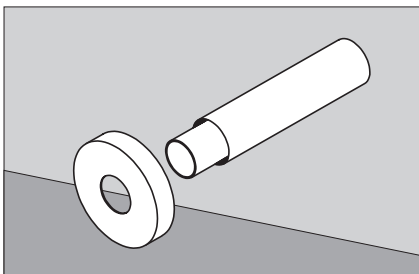
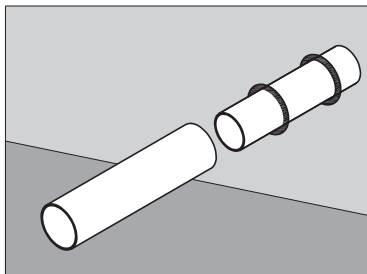
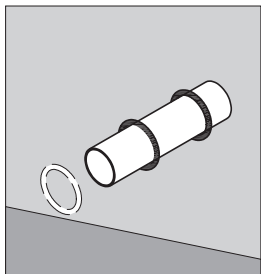
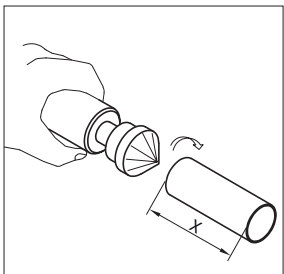

Z = 13 mm ALUPEX

Z = 16 mm Cu