

JOTA

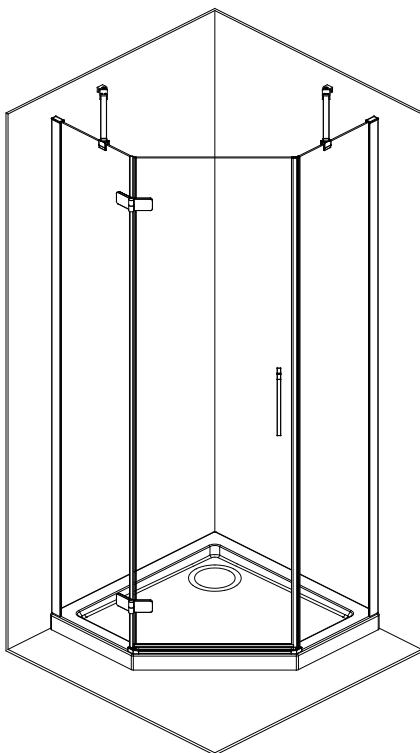

PL INSTRUKCJA MONTAŻU I EKSPLOATACJI
CZ NÁVOD NA MONTÁŽ A ÚDRŽBU
SK NÁVOD NA MONTÁŽ A ÚDRŽBU
EST PAIGALDUS- JA KASUTUSJUHEND
LT MONTAVIMO IR EKSPLOAVIMO INSTRUKCIJA
LV MONTĀŽAS UN EKSPLOATĀCIJAS INSTRUKCIJA
DE MONTAGE- UND AUFBAUANLEITUNG

RO INSTRUCȚIUNI DE MONTAJ ȘI OPERARE
HU SZERELÉSI ÉS ÜZEMELTETÉSI ÚTMUTATÓ
UA ІНСТРУКЦІЯ З МОНТАЖУ І ЕКСПЛУАТАЦІЇ
BY ІНСТРУКЦЫЯ ПА МАНТАЖУ І ЕКСПЛУАТАЦЫІ
RU ИНСТРУКЦИЯ ПО МОНТАЖУ И ЭКСПЛУАТАЦИИ
EN INSTRUCTIONS FOR ASSEMBLY AND USE
FR INSTALLATION ET UTILISATION - MODE

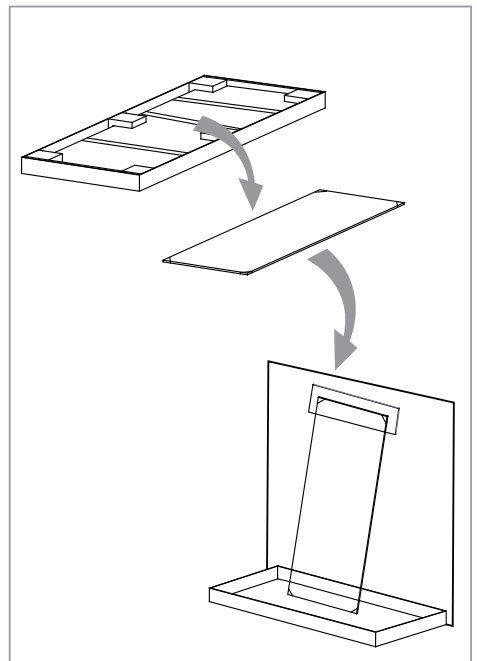
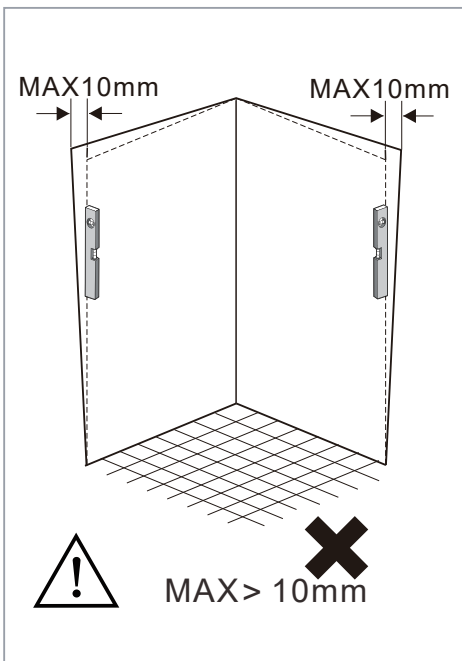
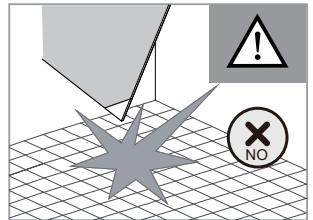
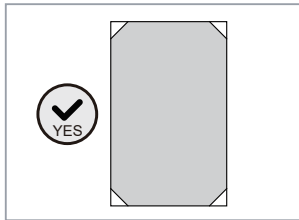
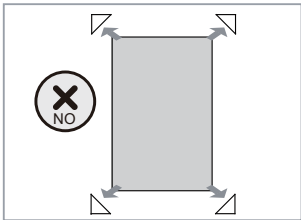
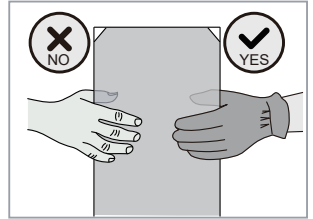
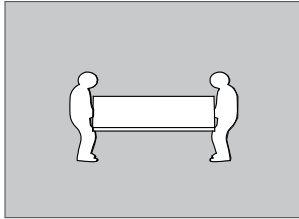
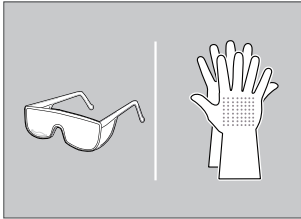
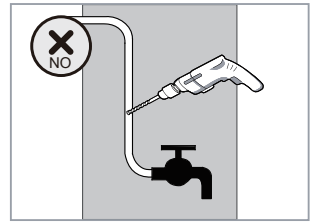
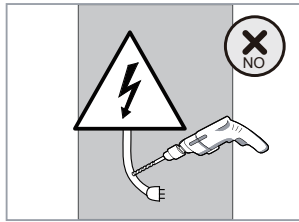
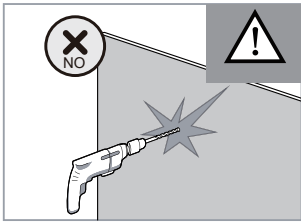

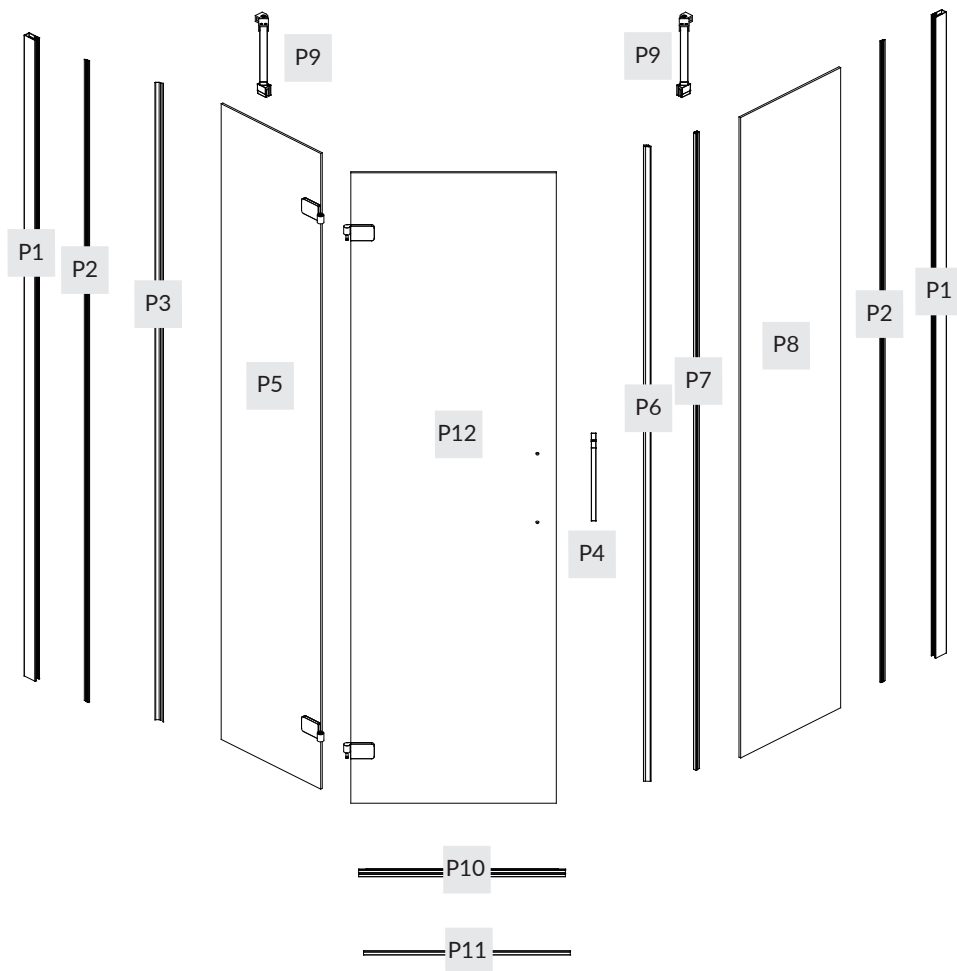

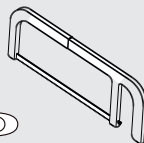
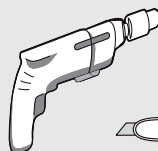
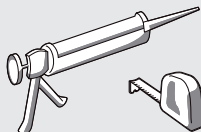
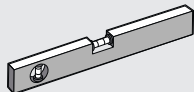
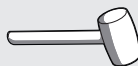
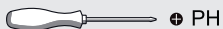
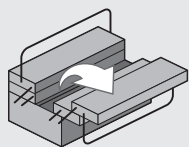
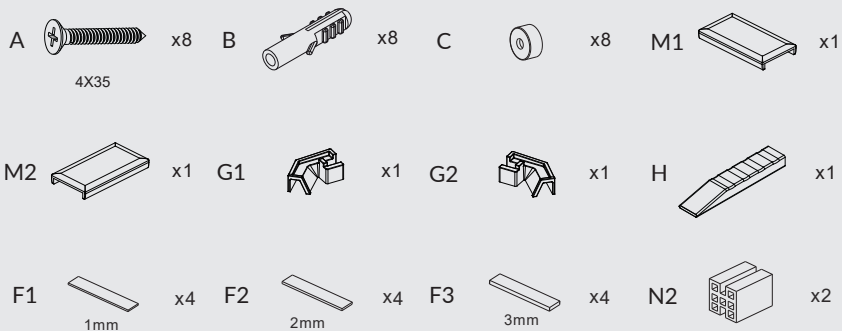
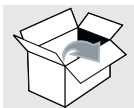

1.

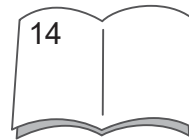
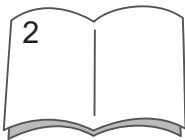
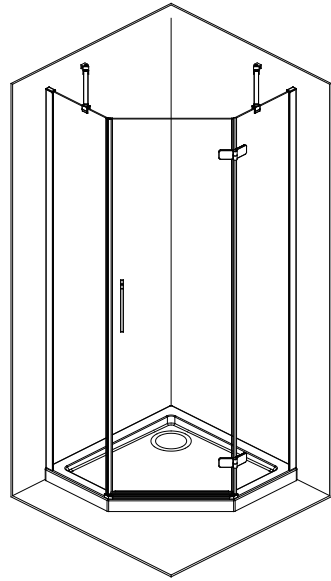
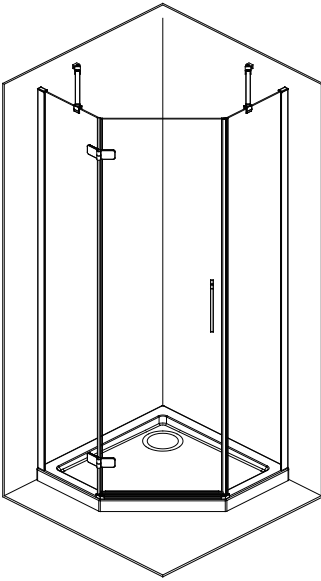

2.

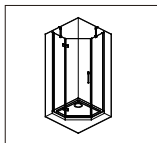

SIZE	X (mm)	Y (mm)
800X800X1950	785	785
900X900X1950	885	885

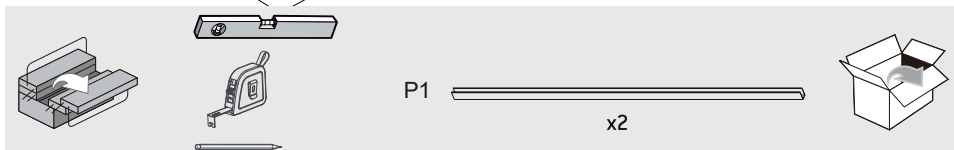
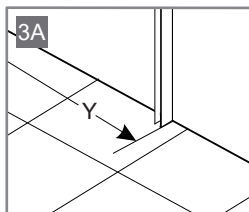
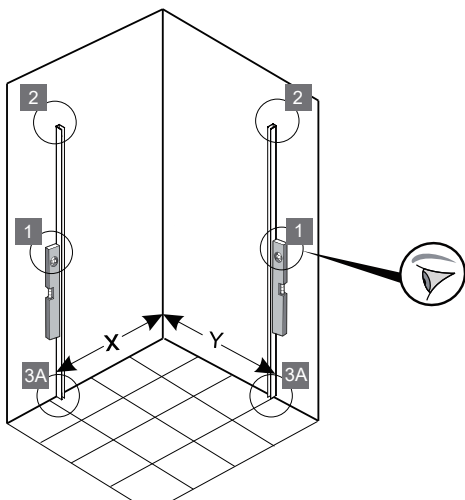
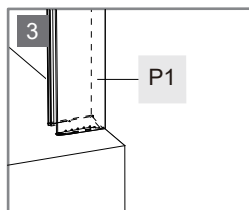
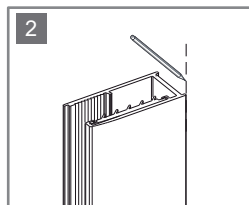
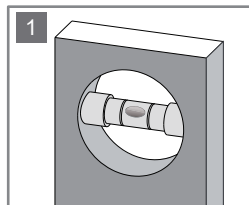
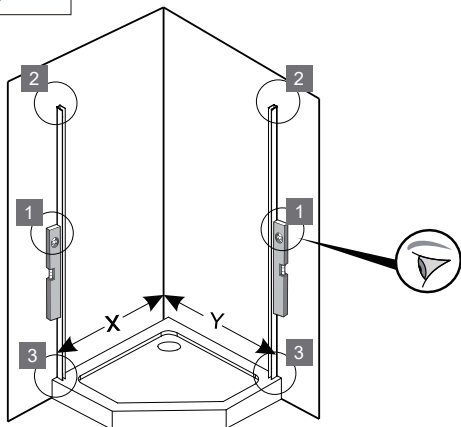

3.

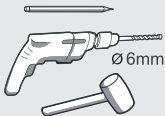
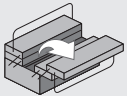
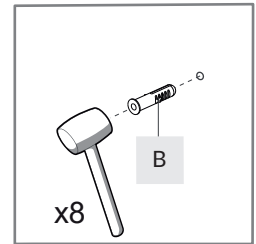
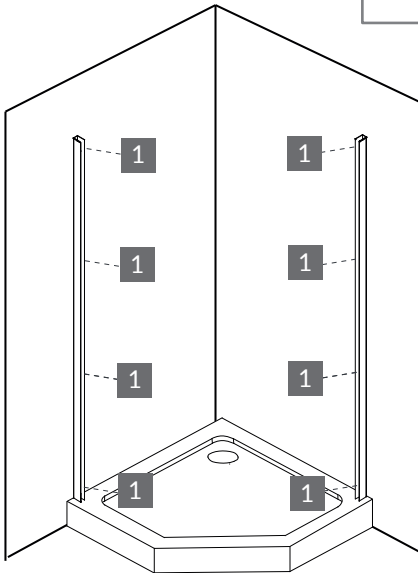
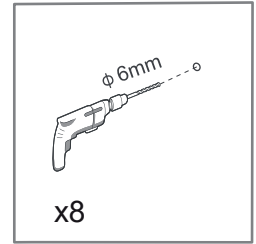
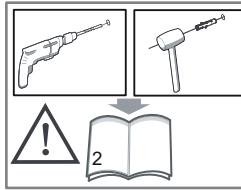
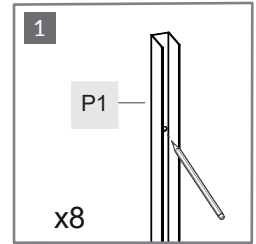
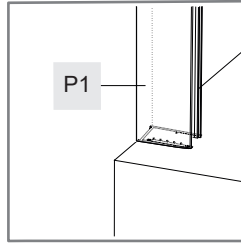
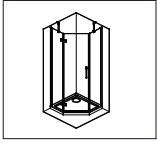

B



x8



4.

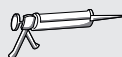
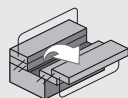
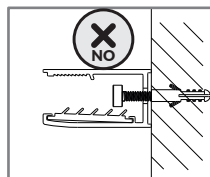
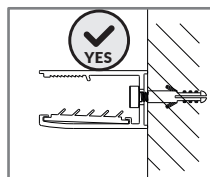
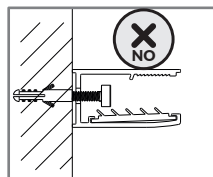
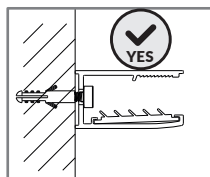
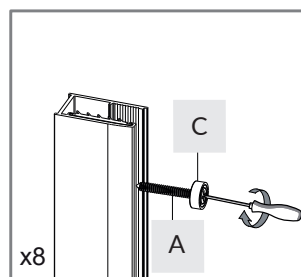
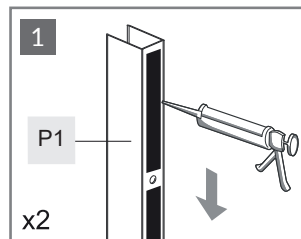
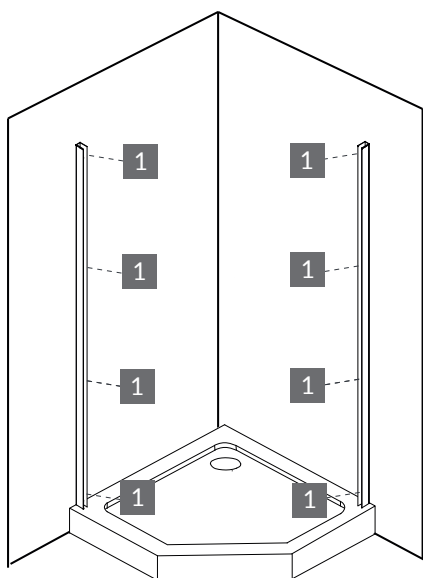
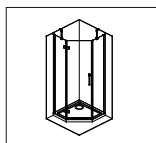

P1

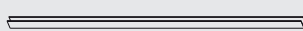

x2



PH2

C



x8

A



4x35

x8



5.

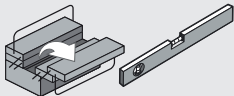
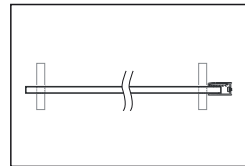
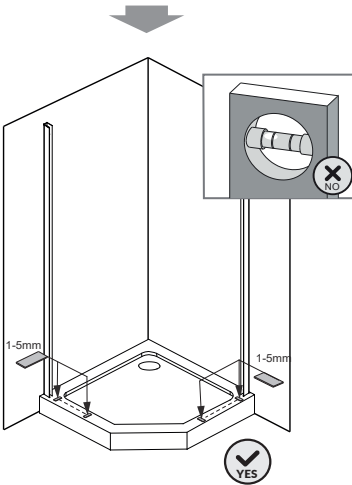
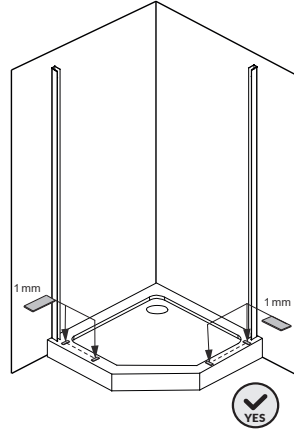
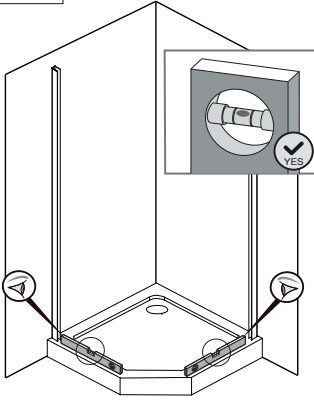
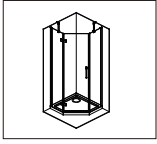

F1



1mm

x4

F2



2mm

x4

F3



3mm

x4



6.

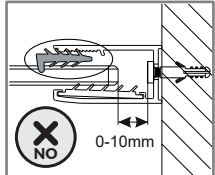
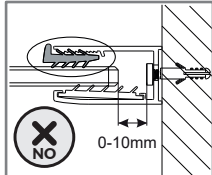
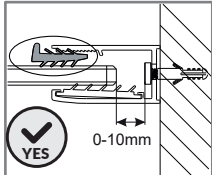
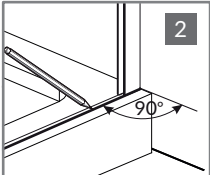
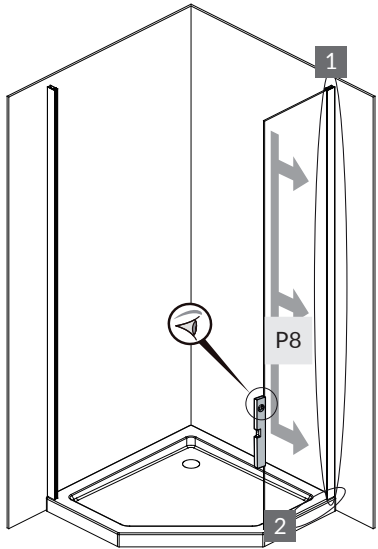
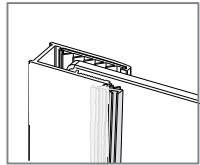
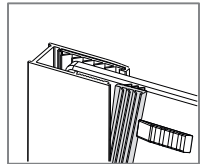
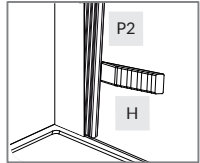
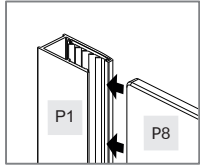
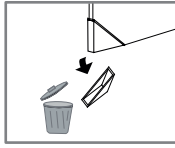
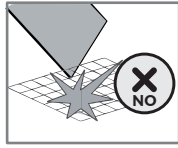
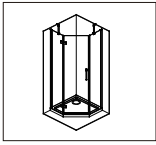

		P2		x1	
		H		x1	

7.

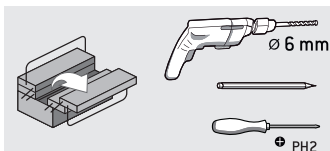
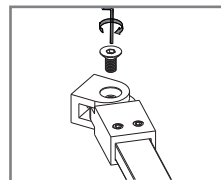
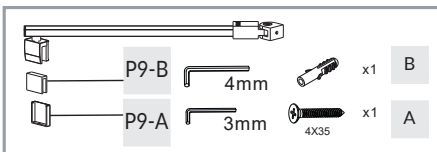
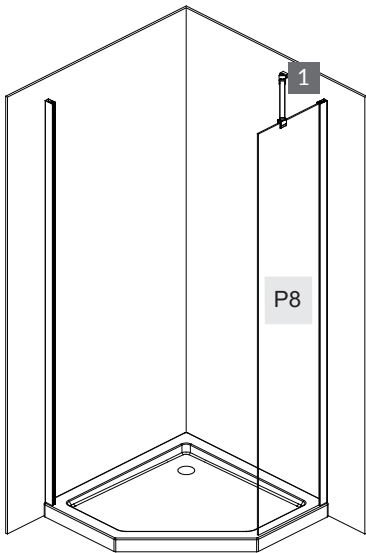
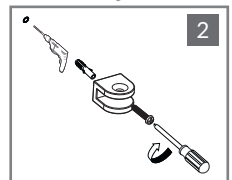
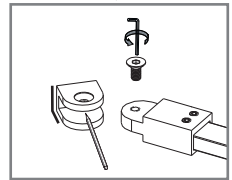
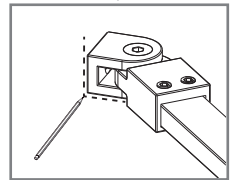
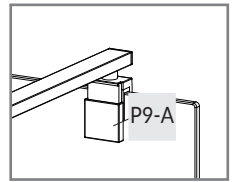
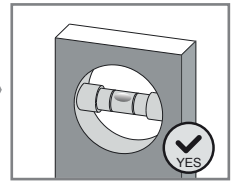
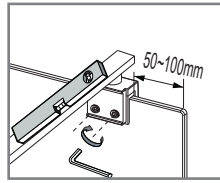
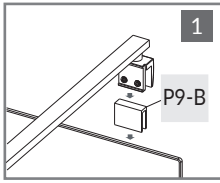
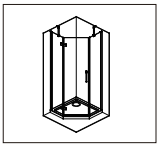

8.

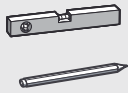
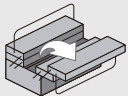
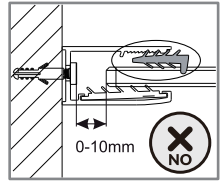
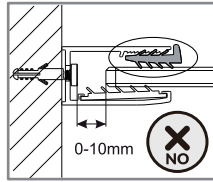
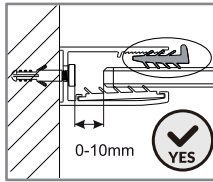
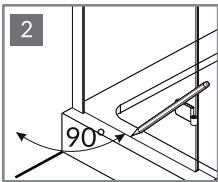
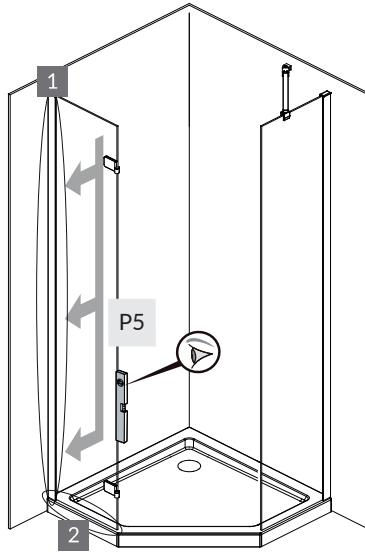
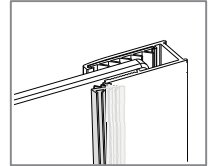
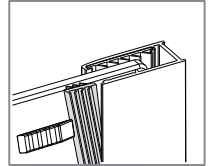
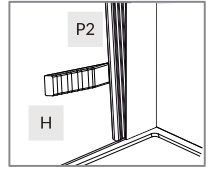
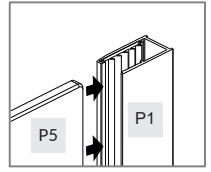
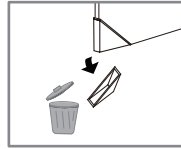
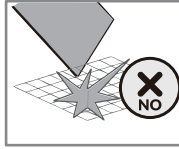
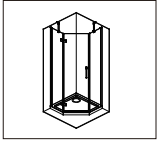

P2 ————— x1

H ————— x1



9.

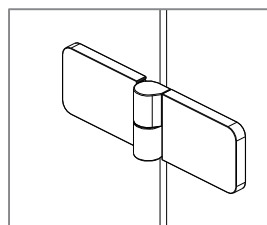
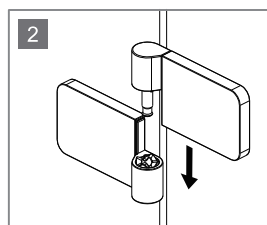
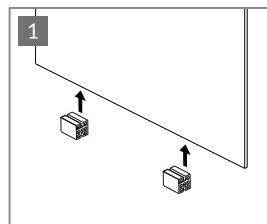
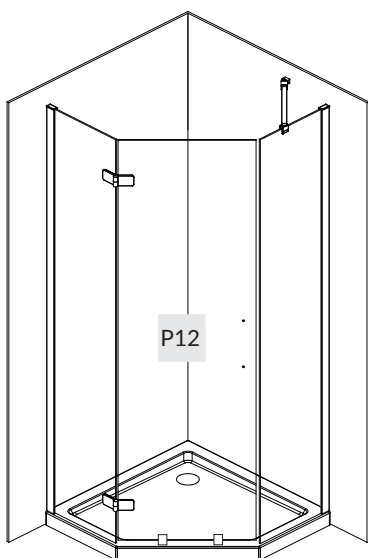
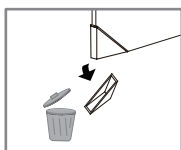
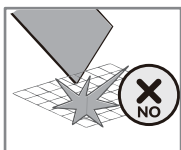
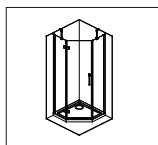

N2



x2



10.

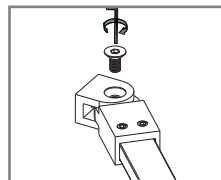
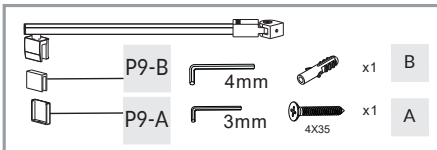
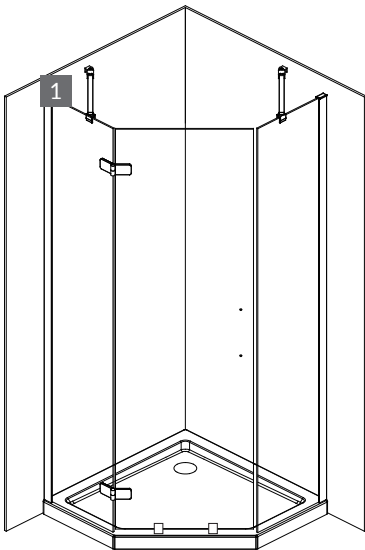
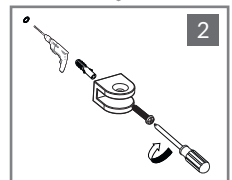
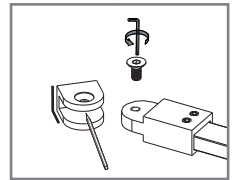
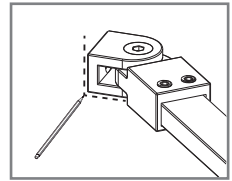
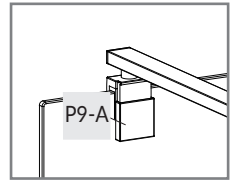
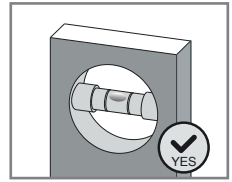
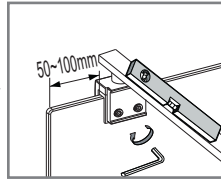
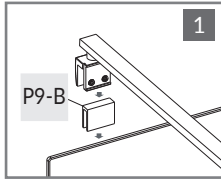
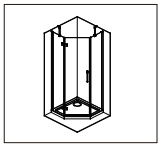

11.

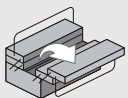
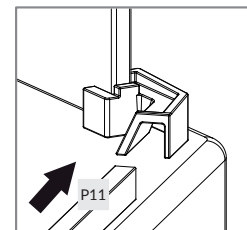
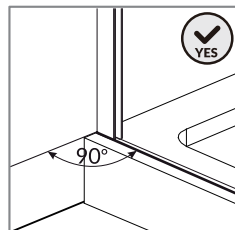
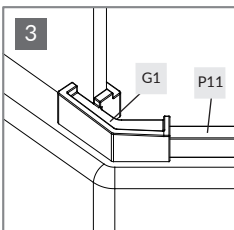
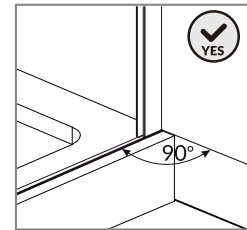
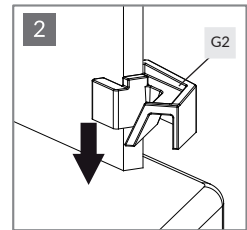
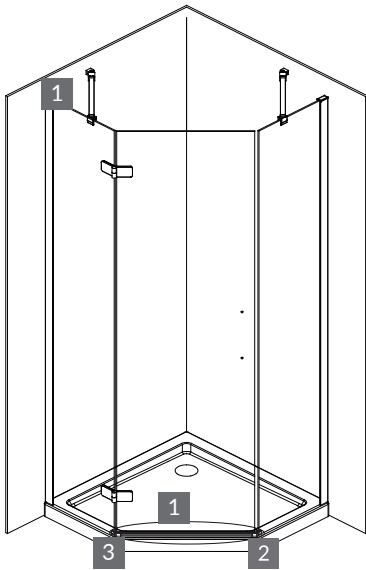
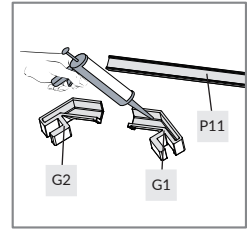
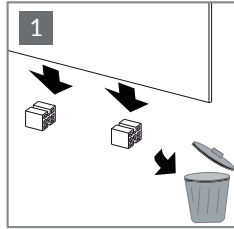
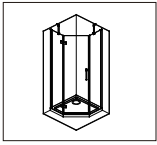

G1  x1

P11  x1

G2  x1



12.

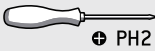
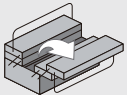
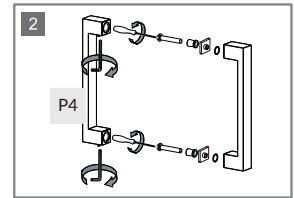
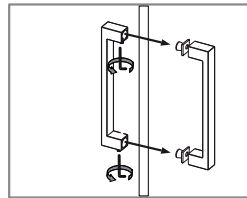
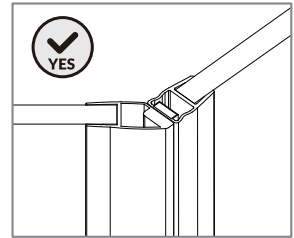
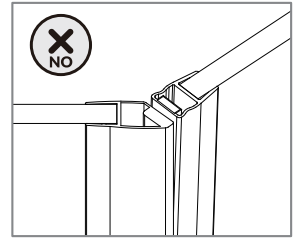
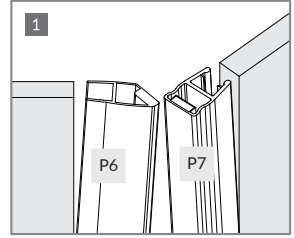
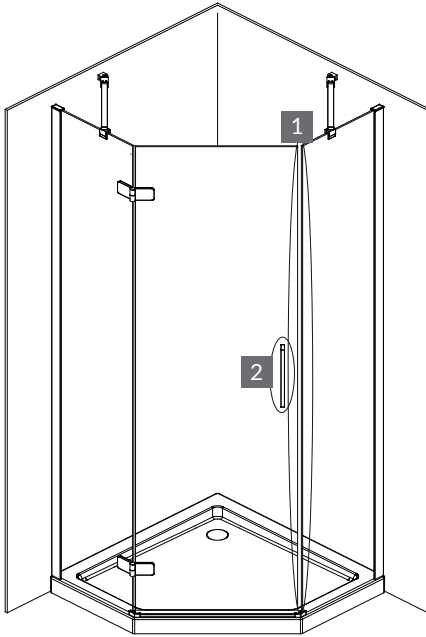
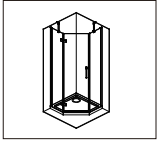

P6 ————— x1

P7 ————— x1

P4  x1 



13.

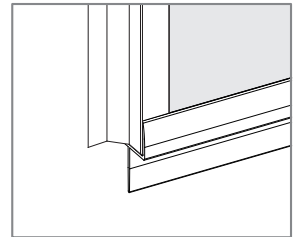
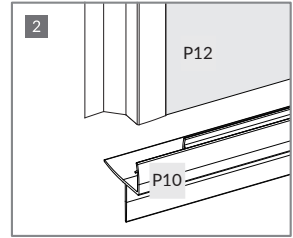
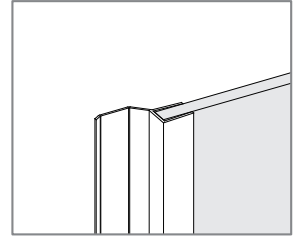
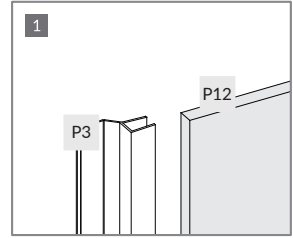
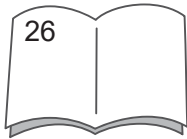
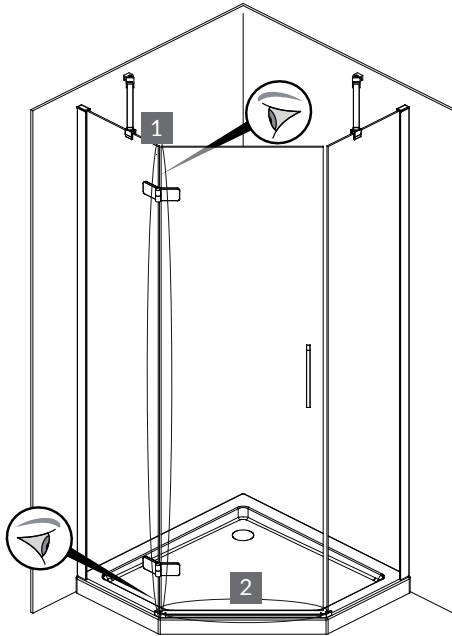
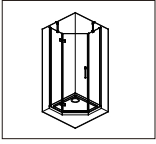

P3 ————— x1

P10 ————— x1



14.

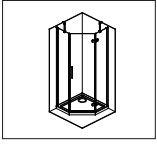

SIZE	X (mm)	Y (mm)
800X800X1950	785	785
900X900X1950	885	885

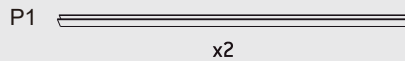
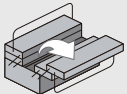
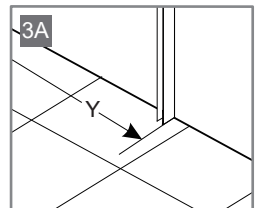
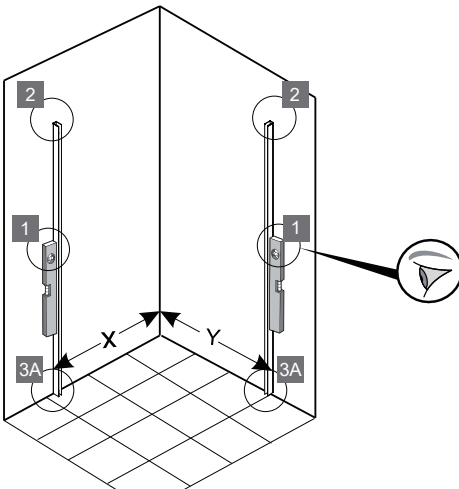
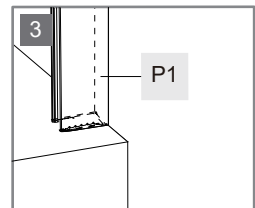
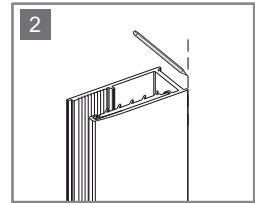
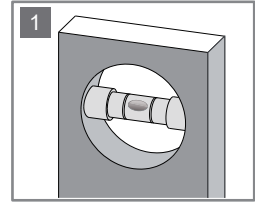
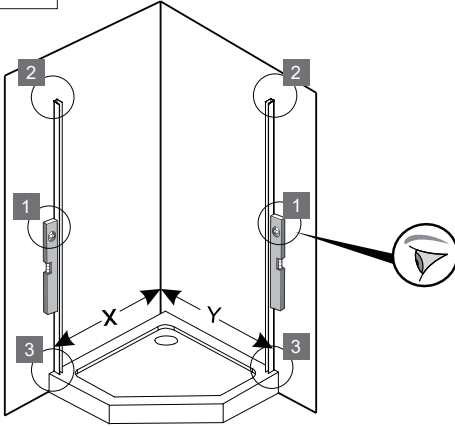

15.

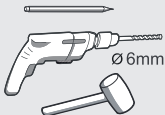
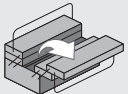
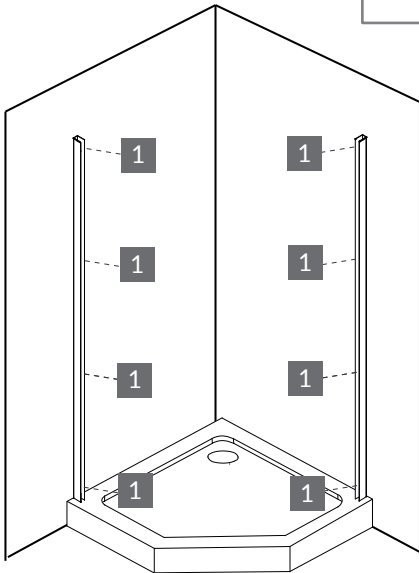
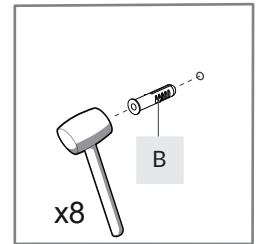
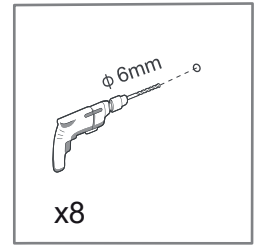
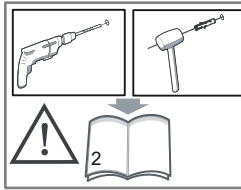
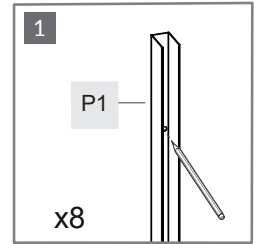
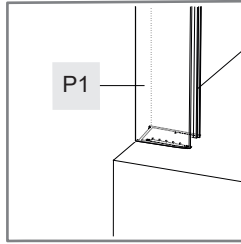
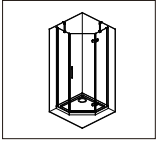

B



x8

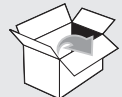

16.

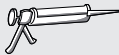
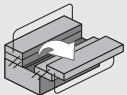
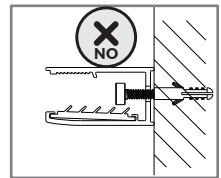
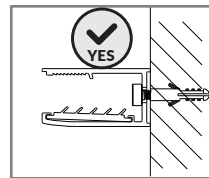
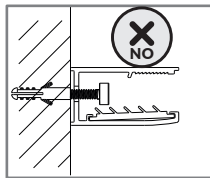
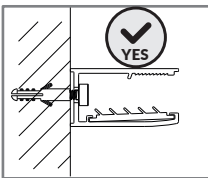
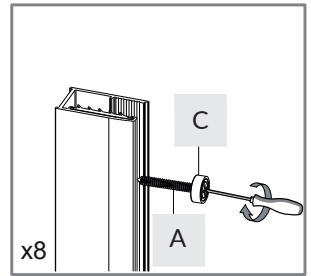
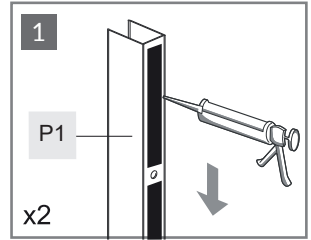
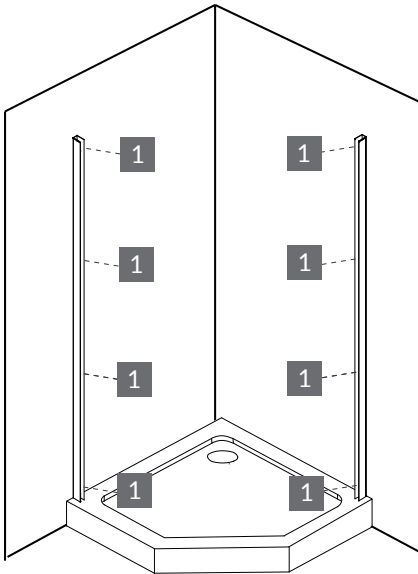
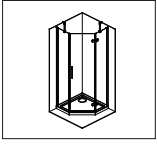

P1



x2



PH2

C



x8

A



4x35

x8



17.

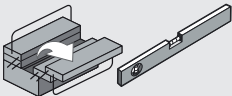
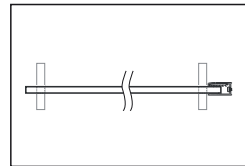
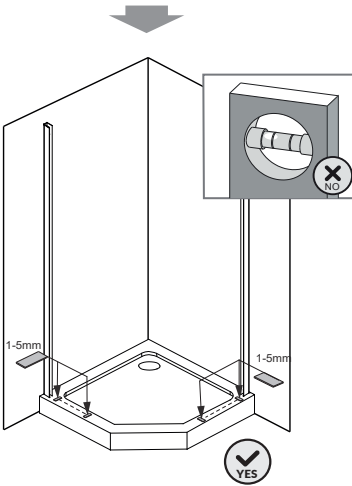
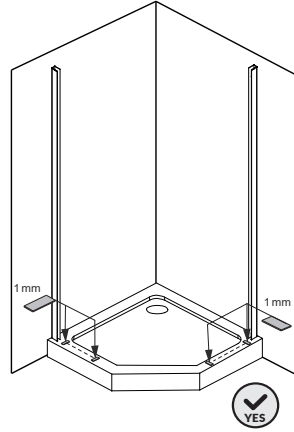
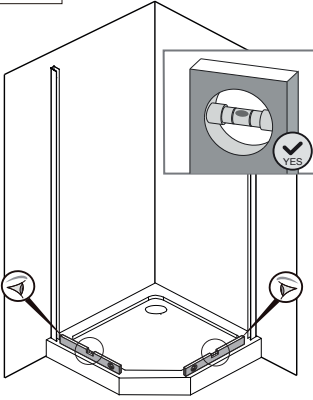
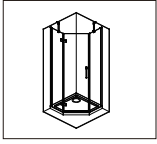

F1



x4

F2



x4

F3



x4



18.

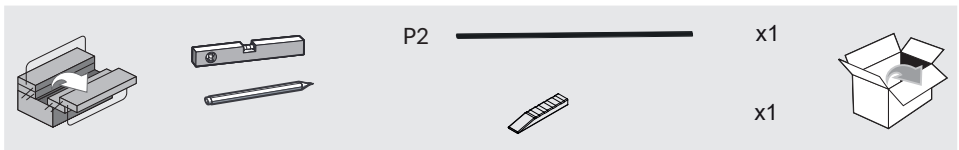
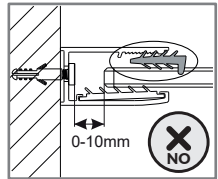
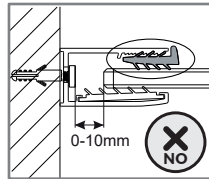
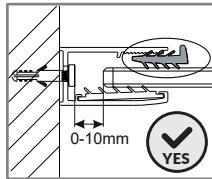
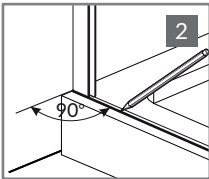
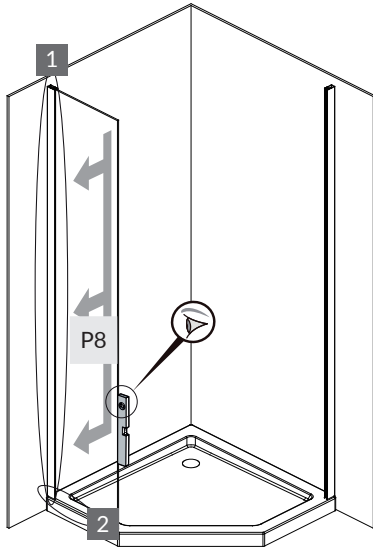
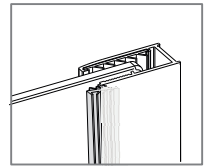
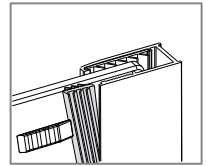
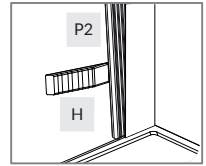
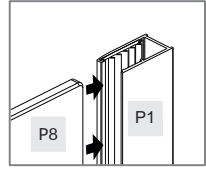
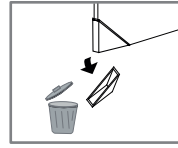
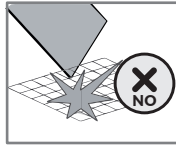
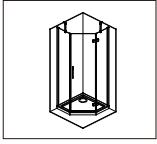

P2

x1

x1

19.

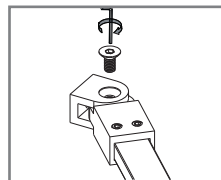
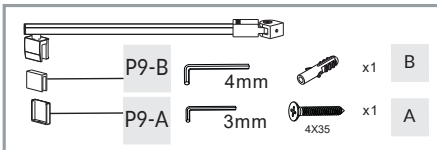
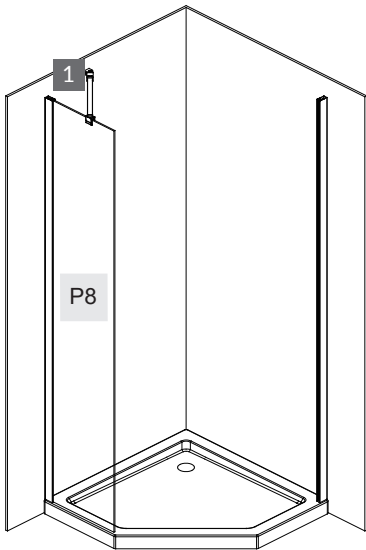
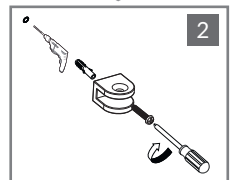
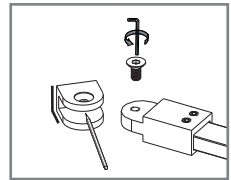
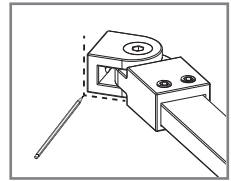
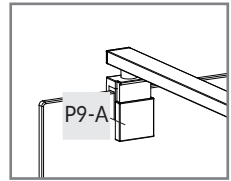
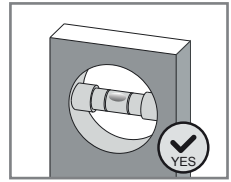
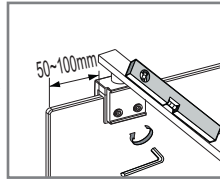
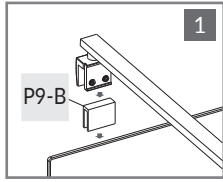
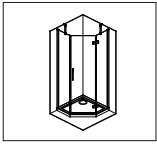

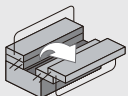
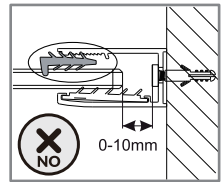
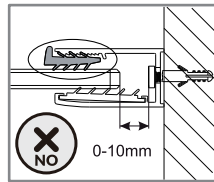
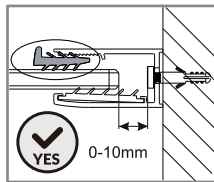
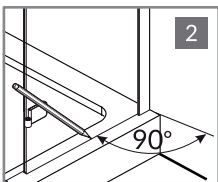
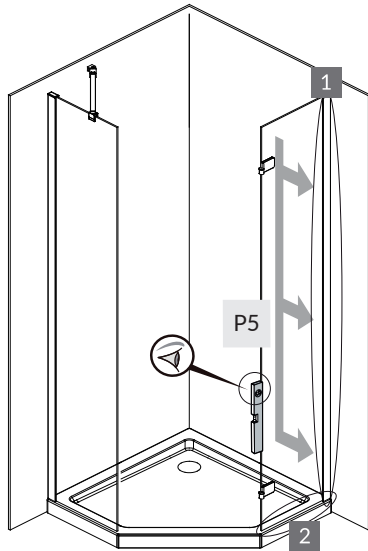
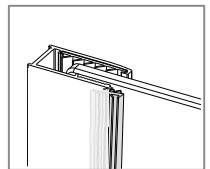
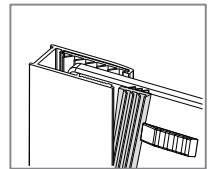
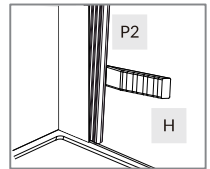
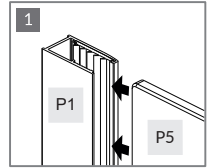
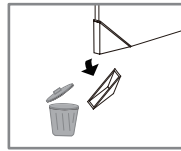
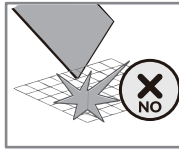
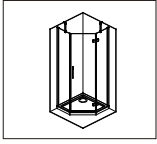

P2 ————— x1

H ————— x1

x1



21.

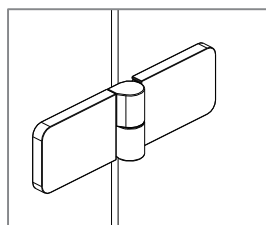
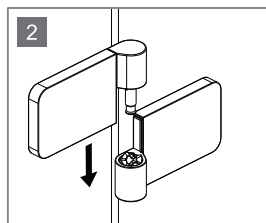
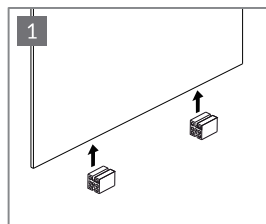
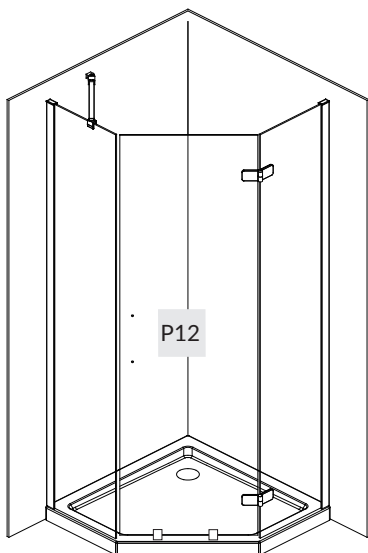
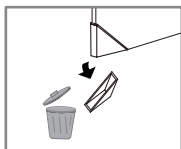
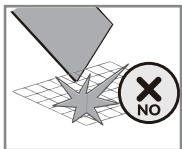
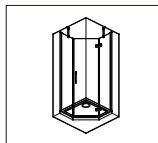

N2



x2



22.

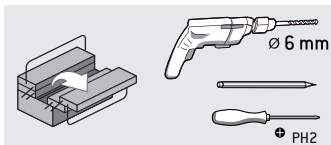
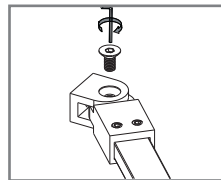
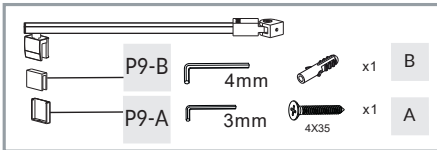
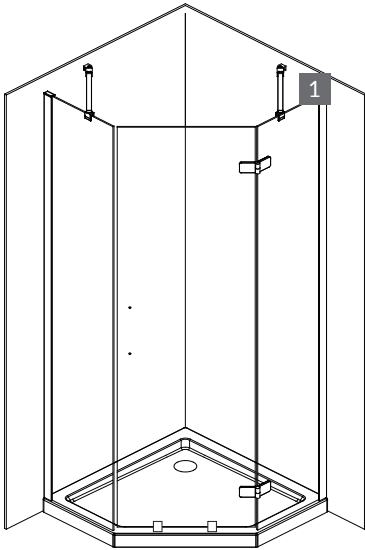
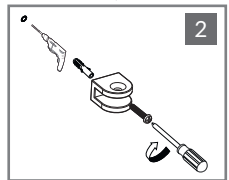
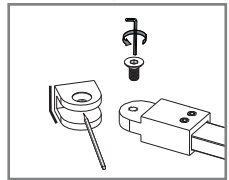
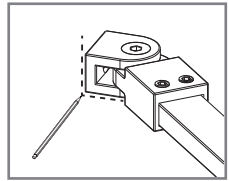
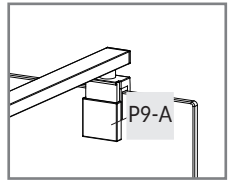
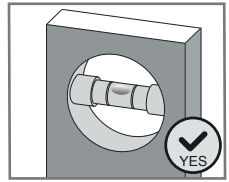
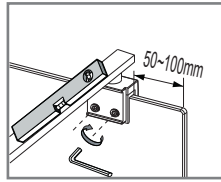
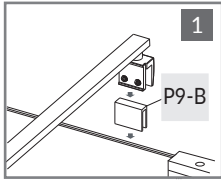
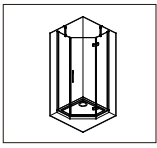

23.

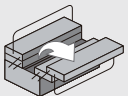
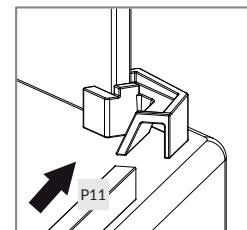
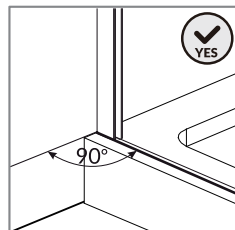
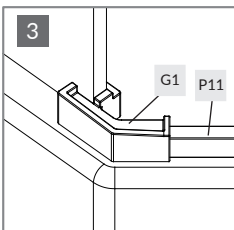
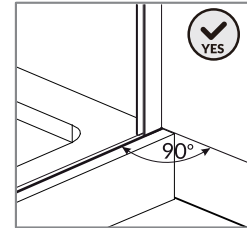
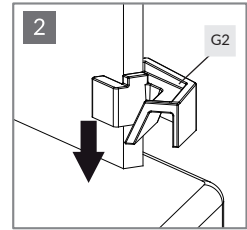
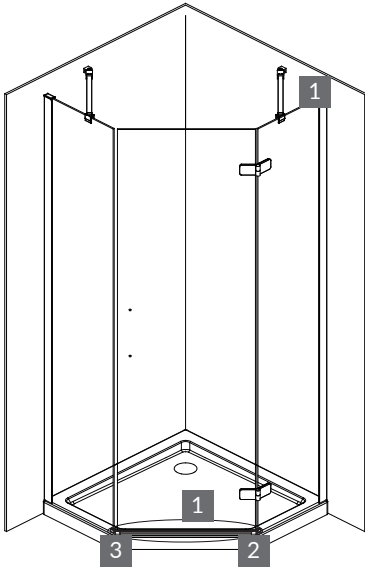
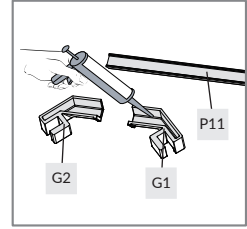
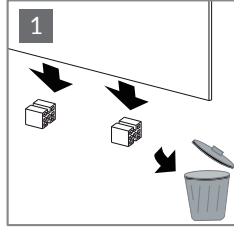
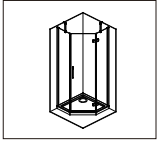

G1



x1

P11

x1

G2



x1



24.

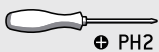
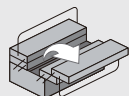
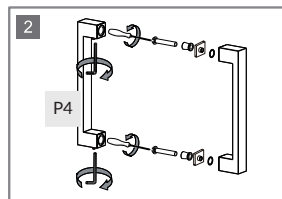
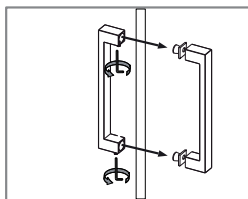
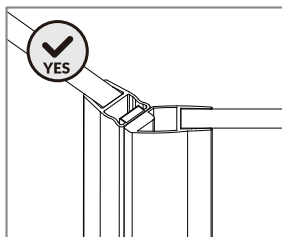
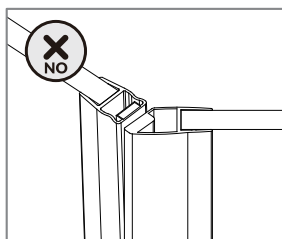
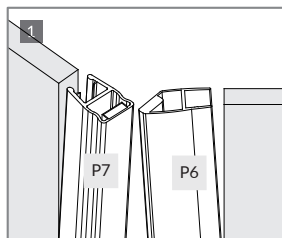
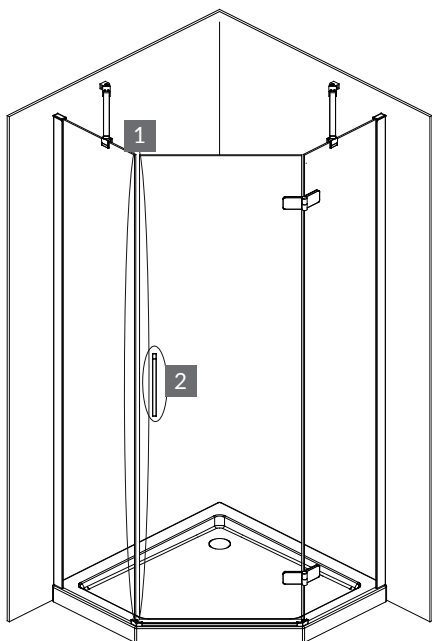
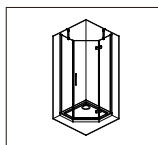

PH2

P6 ————— x1

P7 ————— x1

P4  x1 



25.

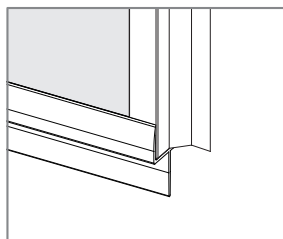
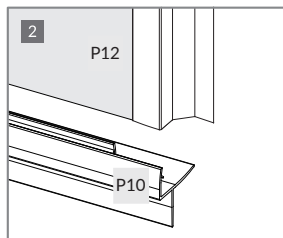
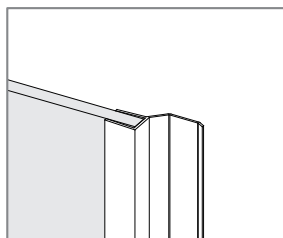
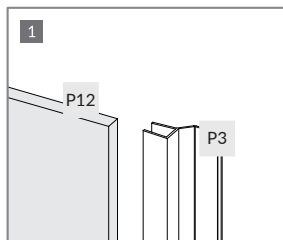
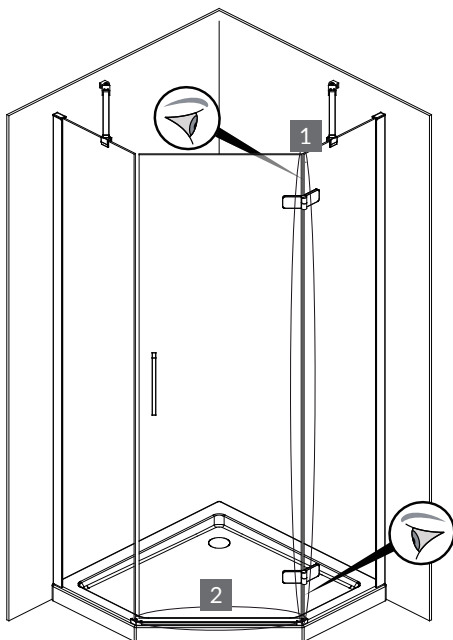
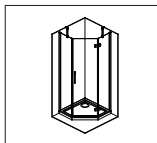

P3 ————— x1

P10 ————— x1



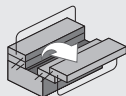
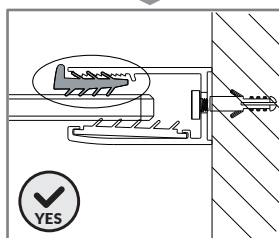
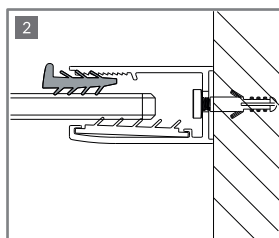
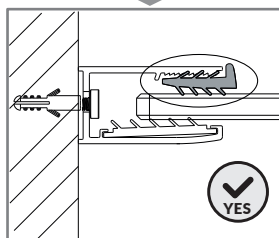
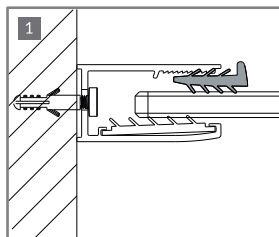
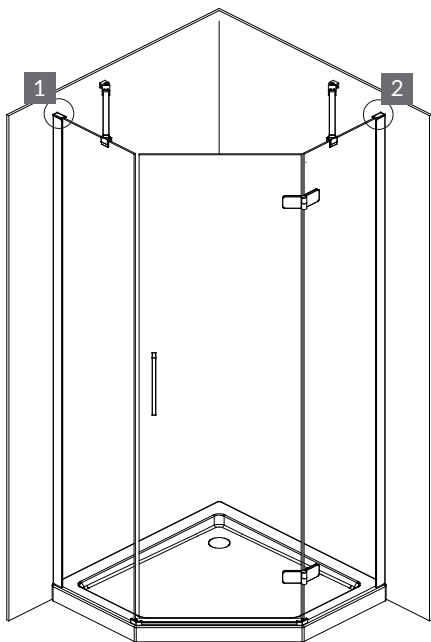

H



x1



27.

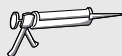
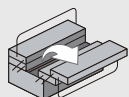
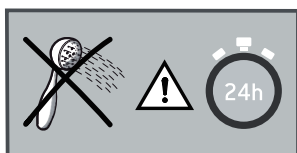
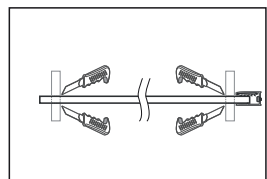
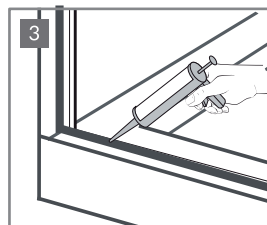
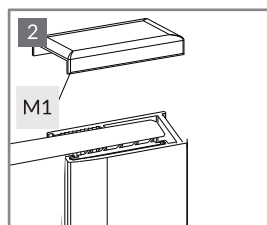
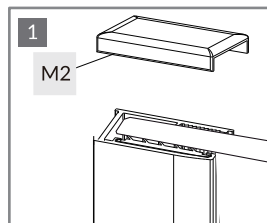
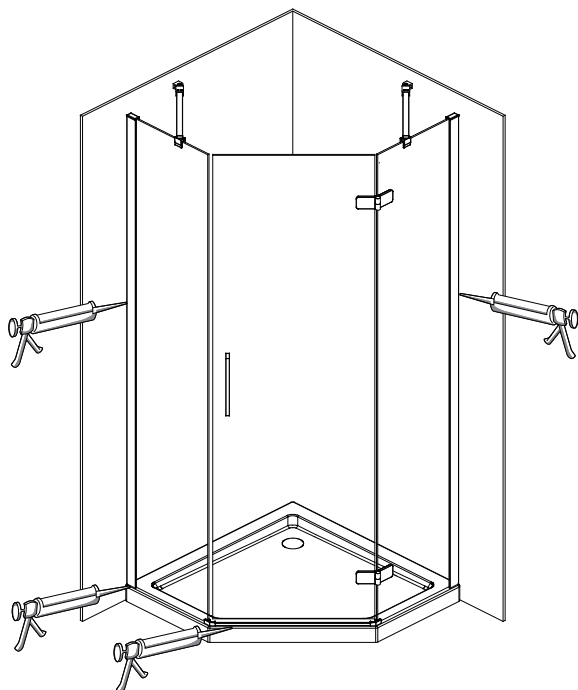

M1

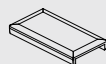

x1

M2



x1





6.5 < PH < 7.5

