

Rea

Koupelna s představivostí

MONTÁŽNÍ NÁVOD

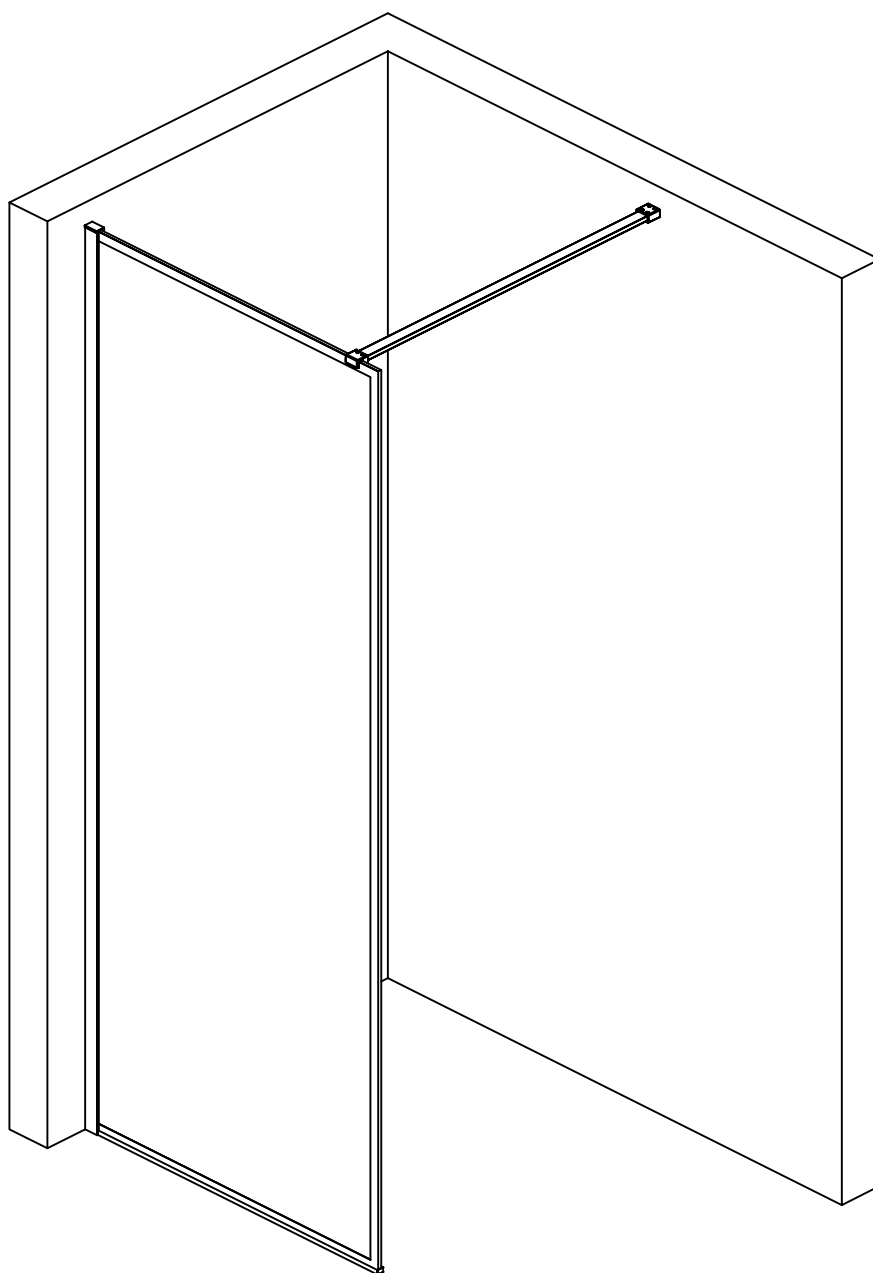

Sprchová zástěna Bler L/P

1. Montážní poznámky

Před zahájením instalace zkontrolujte, zda jsou všechny montážní prvky obsažené v pokynech v balení a zda nejsou poškozené. V případě jejich poškození nebo nedostatku kontaktujte neprodleně prodejce.

UPOZORNĚNÍ: NEINSTALUJTE POŠKOZENÉ PRVKY !!!

Před zahájením instalace si prosím přečtěte montážní návod a zkontrolujte, zda máte potřebné nářadí a všechny součásti k instalaci.

Během instalace nepoužívejte ostré nebo tvrdé nástroje, aby nedošlo k poškození skla. V případě potřeby použijte gumové kladivo.



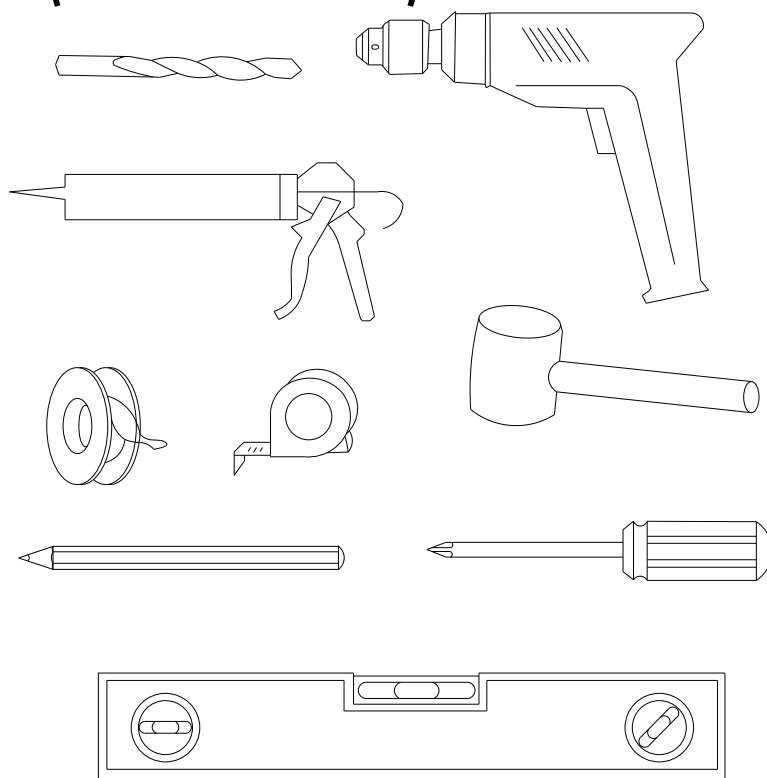





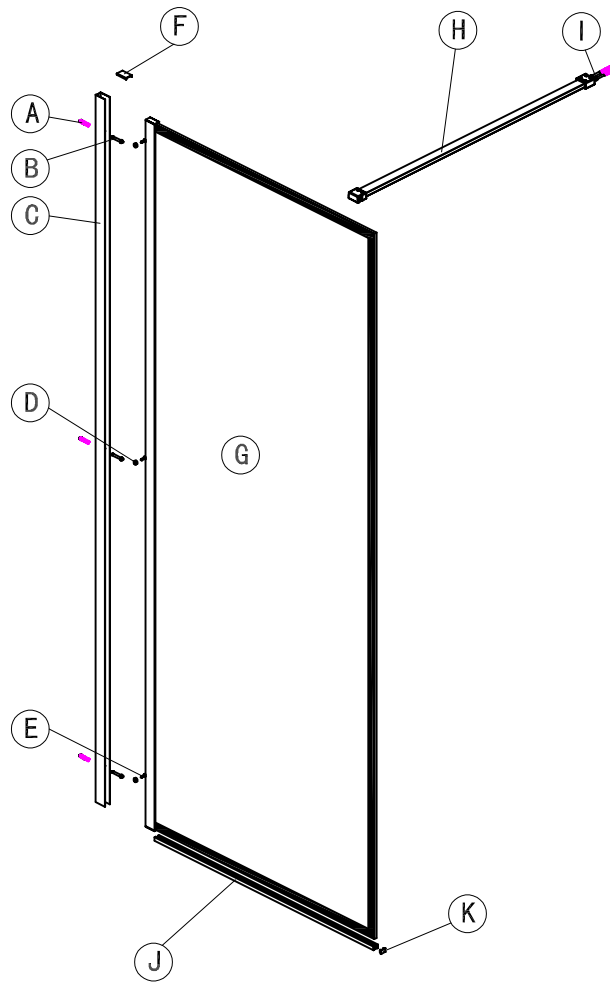





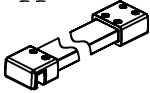

2. Potřebné nářadí (není součástí balení)

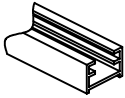

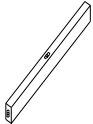
3. Varování

- 1) Osoby, které se necítí dobře nebo jsou pod vlivem alkoholu by neměly sprchovou zástěnu používat.
 - 2) Lidé, kteří trpí srdečními chorobami a vysokým krevním tlakem by měli být při používání sprchové zástěny obzvláště opatrní.
 - 3) Děti a starší lidé by měli sprchovou zástěnu používat pod dohledem dospělé osoby.
 - 4) Při vstupu a výstupu ze sprchové zástěny buďte obzvláště opatrní. Aby jste se vyhnuli poškození zástěny a ztrátě rovnováhy, neopírejte se o sklo.
 - 5) Upravte dobu koupání podle své nálady.
 - 6) Při nastavování teploty vody se nesmí zapnout pouze horká voda.
 - 7) Ve sprchové zástěně je zakázáno kouřit.
-
- 1) Denní čištění lze provádět běžnými čistícími prostředky a měkkým hadříkem. Nedoporučuje se používat prostředky na bázi acetonu a amoniaku.
 - 2) Skvrny lze odstranit octem.
 - 3) Po vyčištění nechte dvířka otevřená, aby rychleji vyschla.



<p>A</p>  <p>X5</p>	<p>B</p>  <p>ST4. 2x32 X3</p>	<p>C</p>  <p>X1</p>	<p>D</p>  <p>X3</p>	<p>E</p>  <p>ST3. 5x9. 5 X3</p>	<p>F</p>  <p>X1</p>	<p>G</p>  <p>X1</p>	<p>H</p>  <p>X1</p>
<p>I</p>  <p>ST4. 2x32 X2</p>	<p>J</p>  <p>X1</p>	<p>K</p>  <p>X1</p>					
				 <p>∅6</p>		 <p>∅2.5</p>	