

CREA

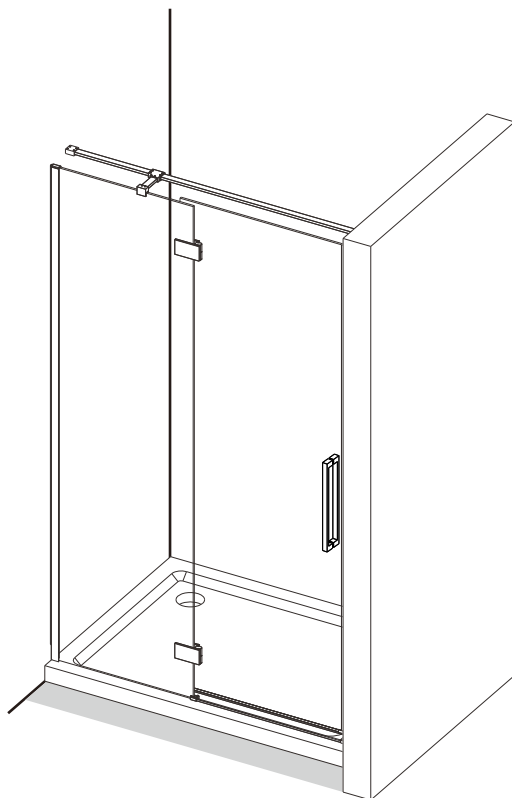

PL INSTRUKCJA MONTAŻU I EKSPLOATACJI

CZ NÁVOD NA MONTÁŽ A ÚDRŽBU

SK NÁVOD NA MONTÁŽ A ÚDRŽBU

EST PAIGALDUS- JA KASUTUSJUHEND

LT MONTAVIMO IR EKSPLOATAVIMO INSTRUKCIJA

LV MONTĀŽAS UN EKSPLUATĀCIJAS INSTRUKCIJA

DE MONTAGE- UND AUFBAUANLEITUNG

RO INSTRUCȚIUNI DE MONTAJ ȘI OPERARE

HU SZERELÉSI ÉS ÜZEMELTETÉSI ÚTMUTATÓ

UA ІНСТРУКЦІЯ З МОНТАЖУ І ЕКСПЛУАТАЦІЇ

BY ІНСТРУКЦЫЯ ПА МАНТАЖЫ І ЭКСПЛУАТАЦЫІ

RU ИНСТРУКЦИЯ ПО МОНТАЖУ И ЭКСПЛУАТАЦИИ

EN INSTRUCTIONS FOR ASSEMBLY AND USE

FR INSTALLATION ET UTILISATION - MODE

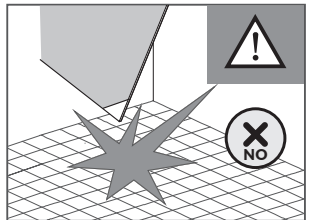
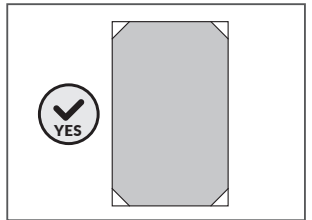
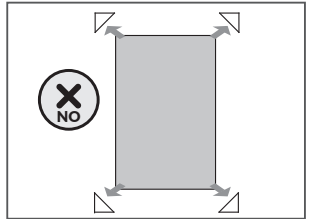
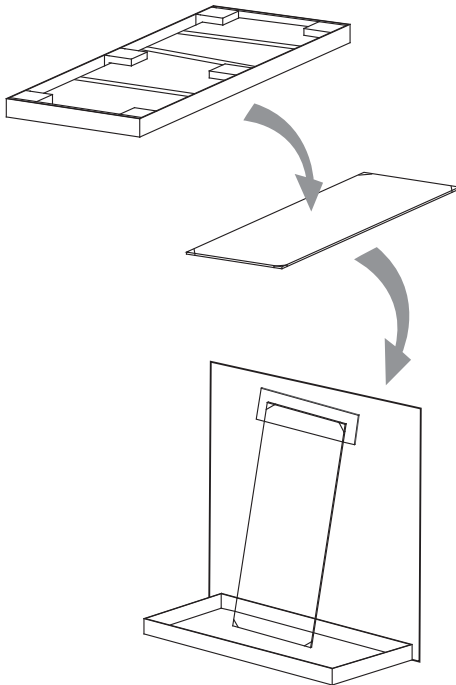
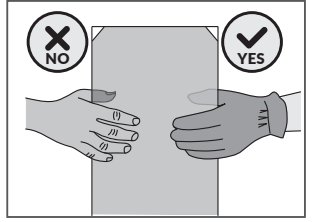
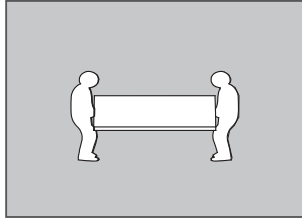
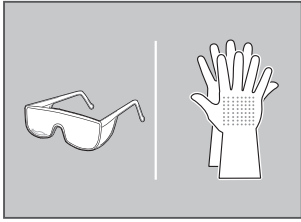
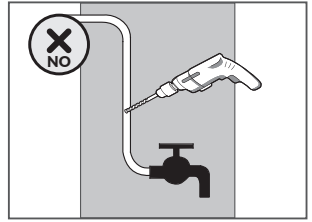
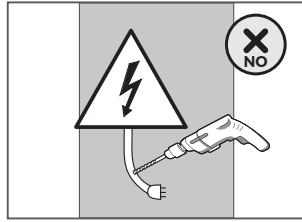
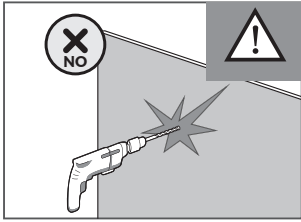

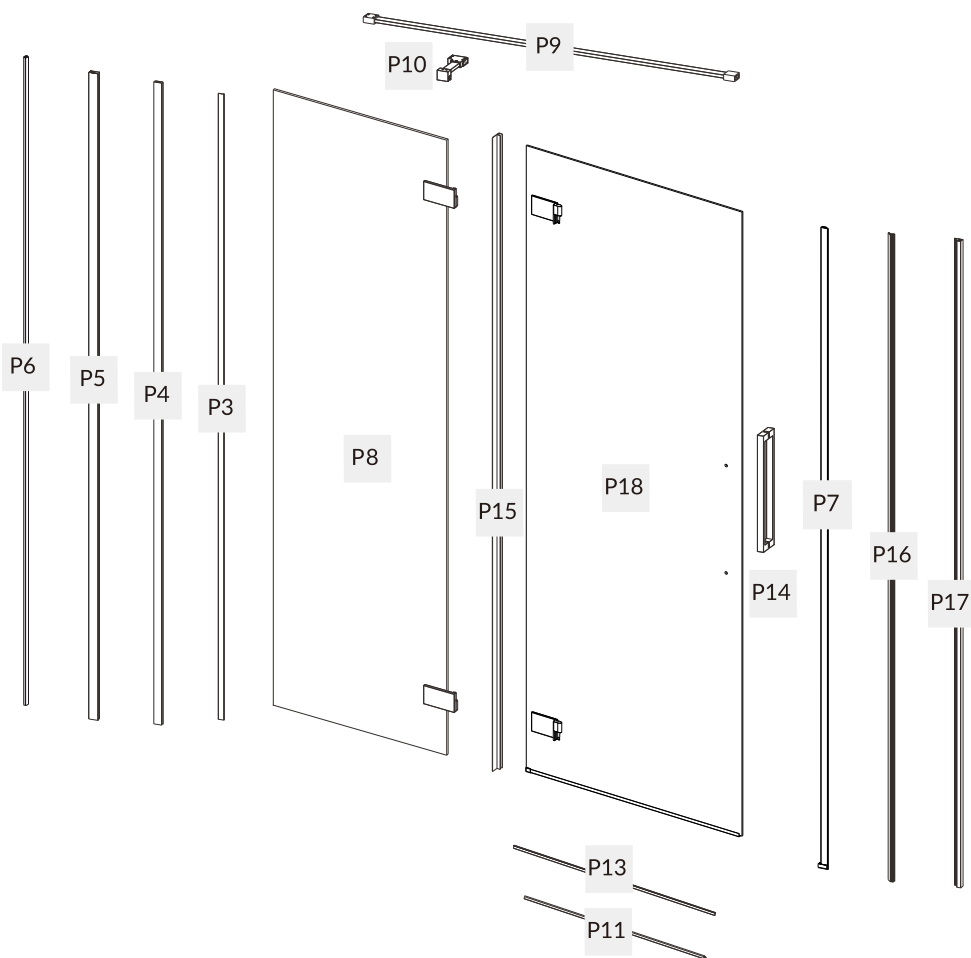

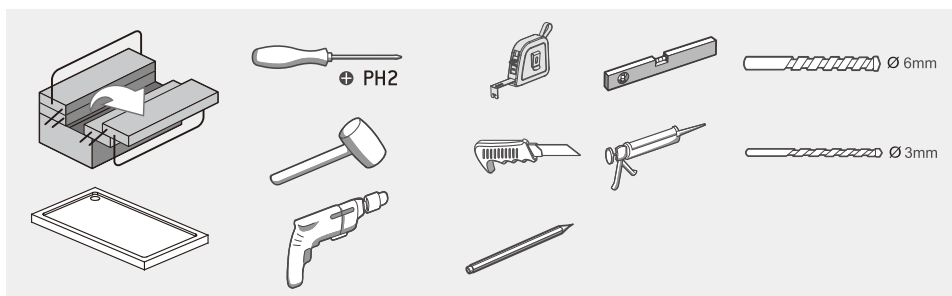
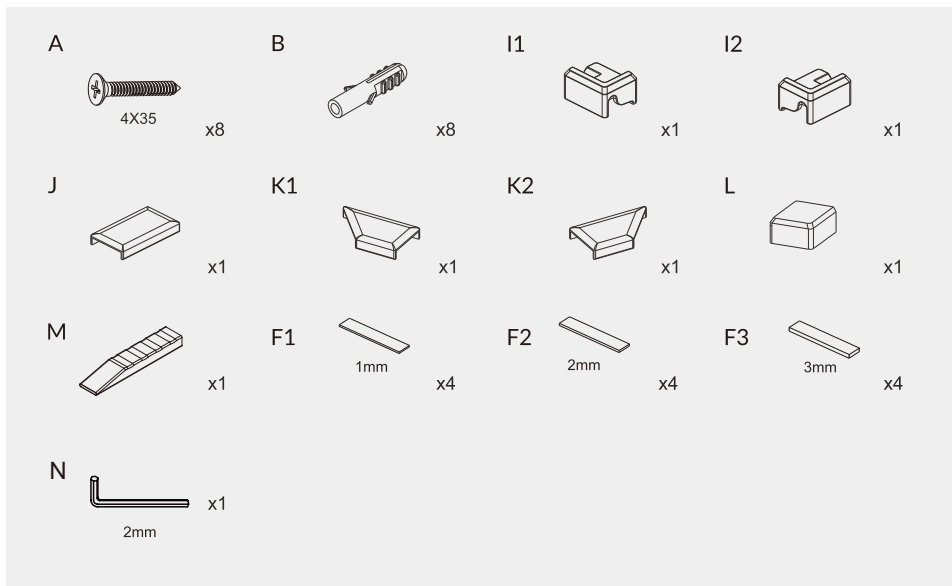

1.

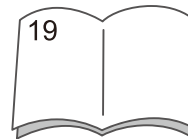
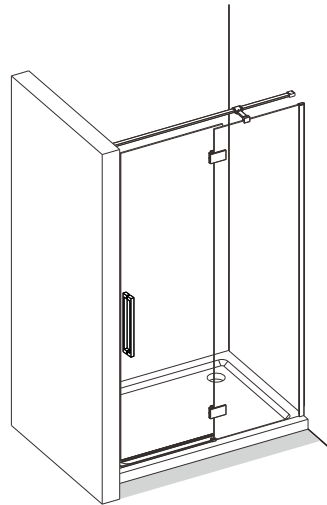
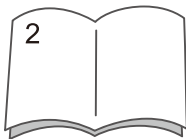
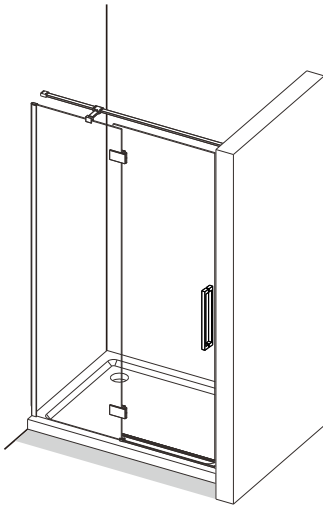

2.

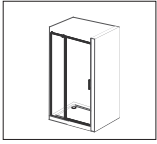

SIZE	X(mm)
900×2000	890-900
1000×2000	990-1000
1200×2000	1190-1200

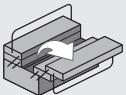
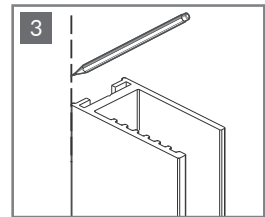
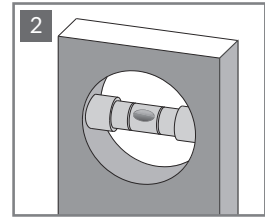
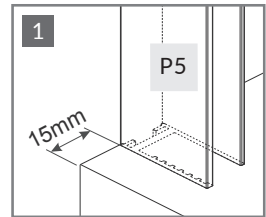
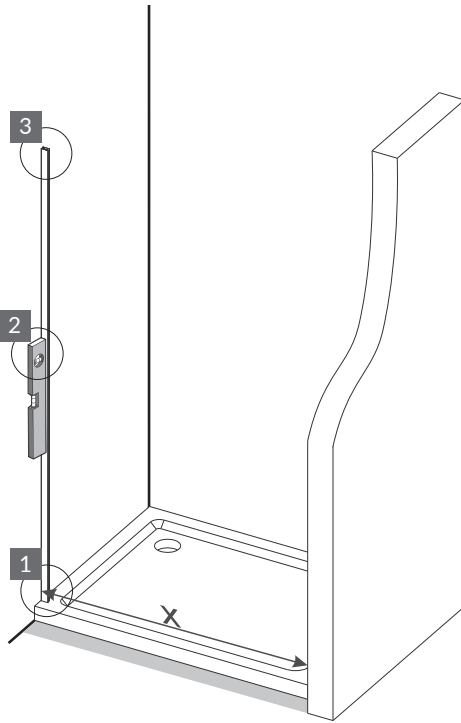

P5



x1



3.

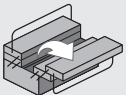
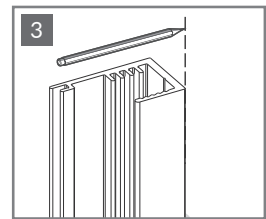
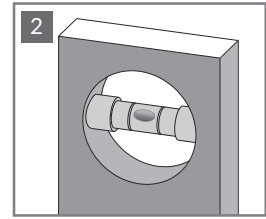
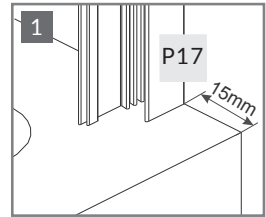
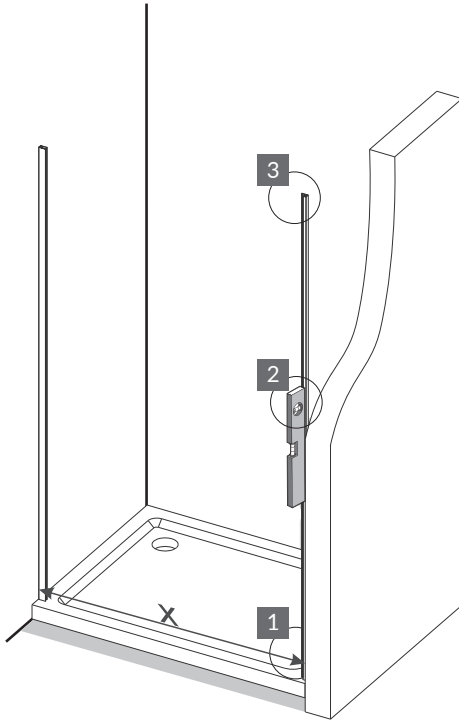
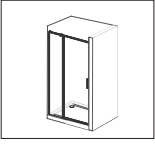

P17



x1



4.

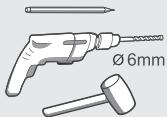
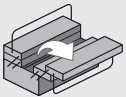
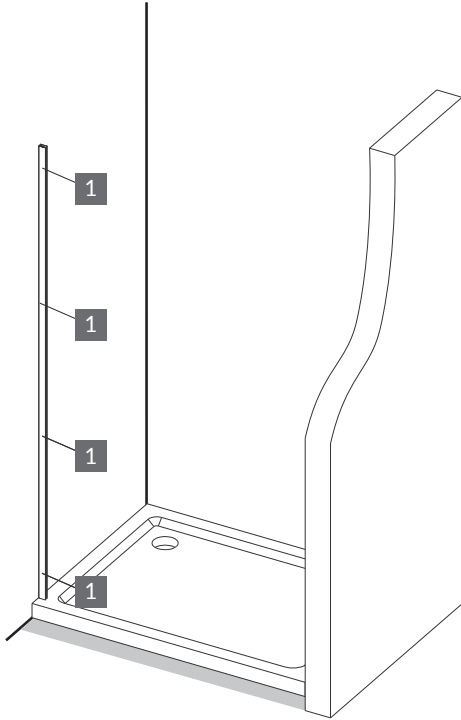
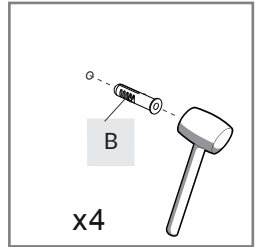
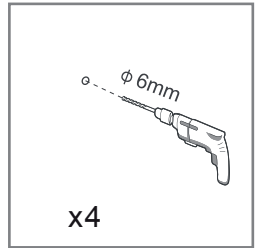
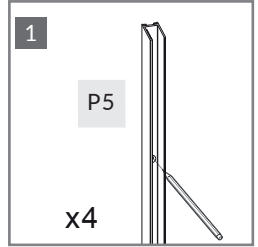
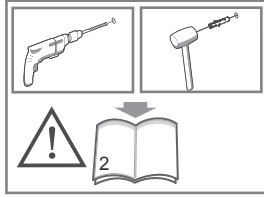
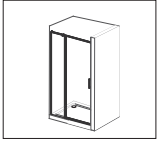

B



x4



5.

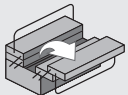
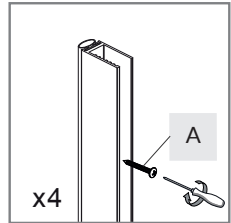
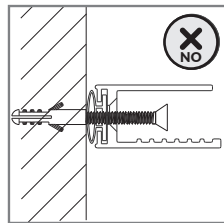
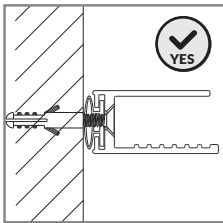
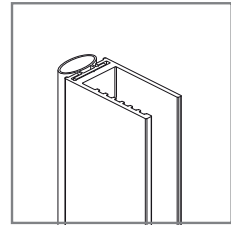
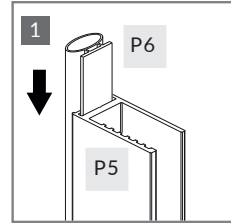
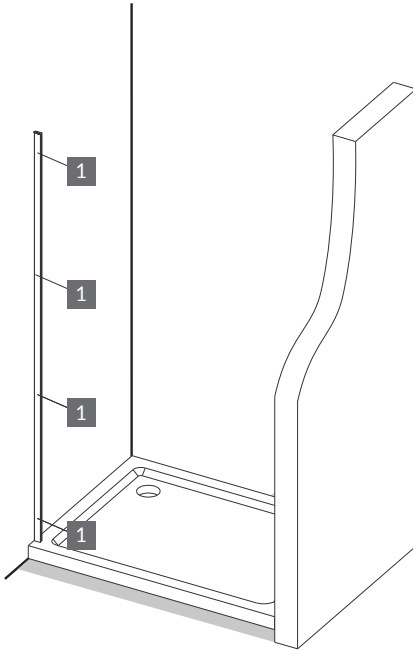
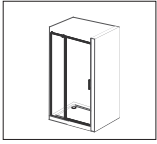

A



x4

P5

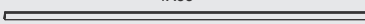

P6



6.

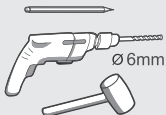
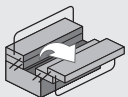
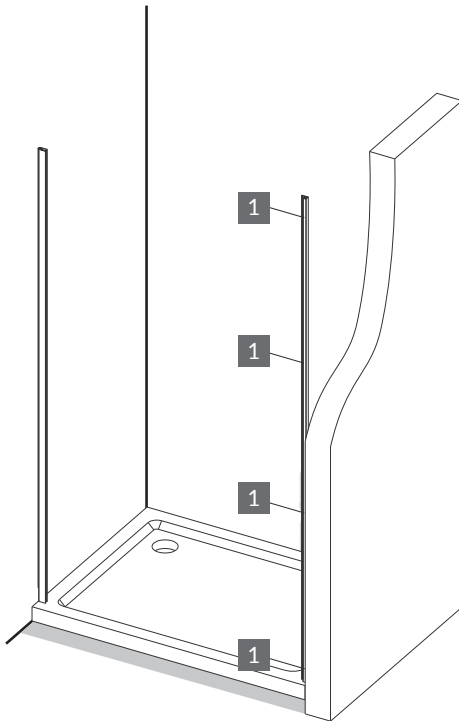
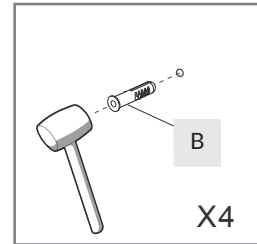
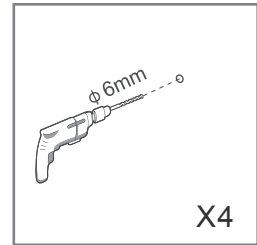
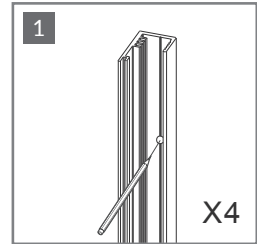
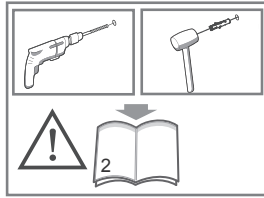
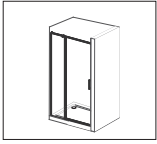

B



x4



7.

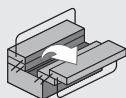
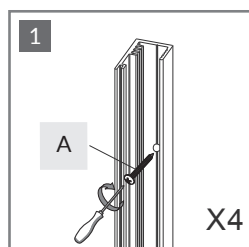
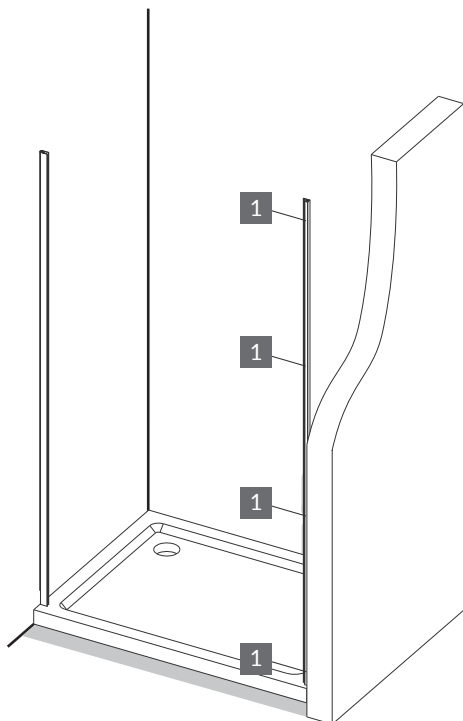

A



x4



8.

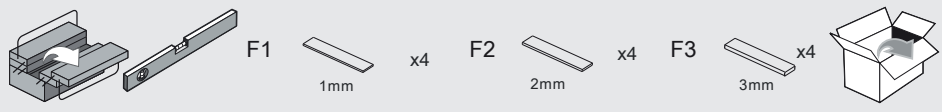
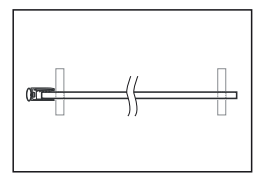
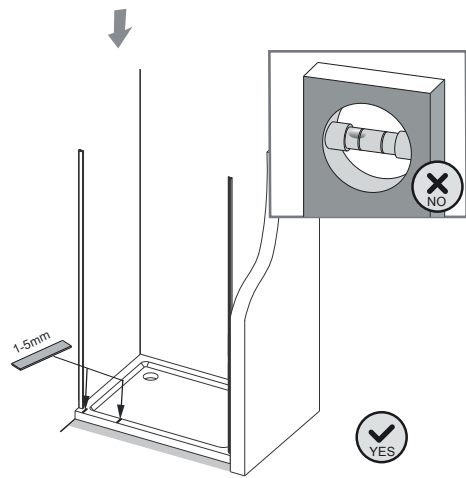
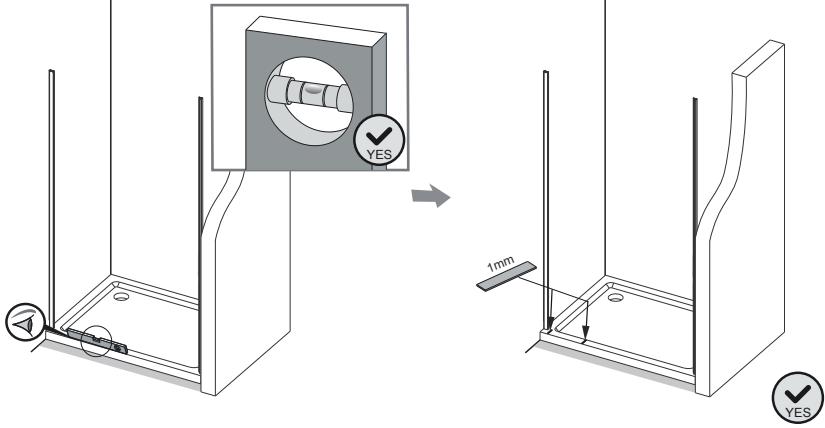
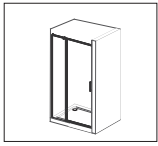

9.

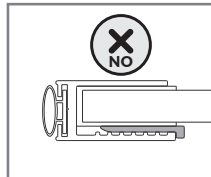
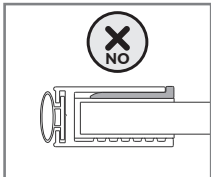
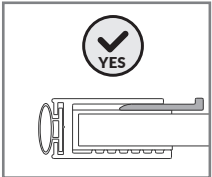
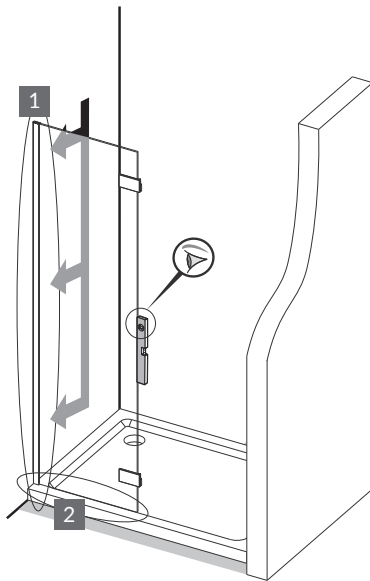
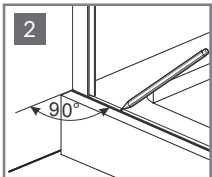
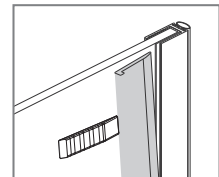
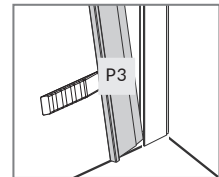
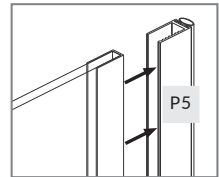
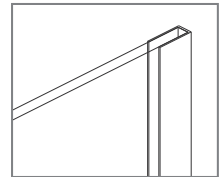
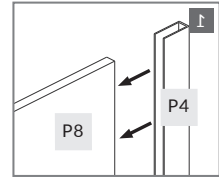
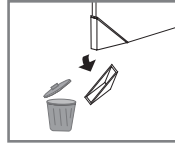
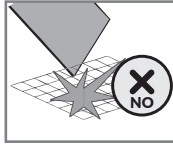
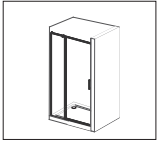

		P4		x1	
	P3		x1		
	M		x1		

10.

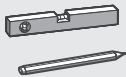
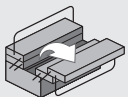
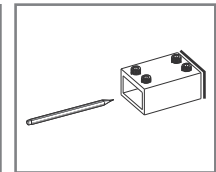
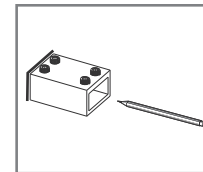
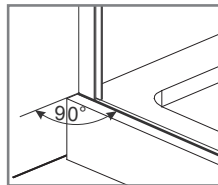
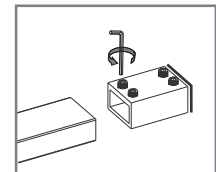
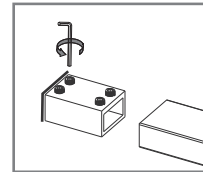
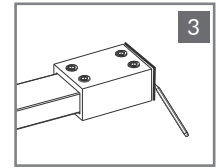
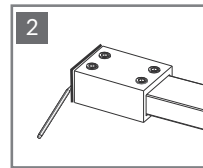
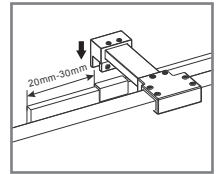
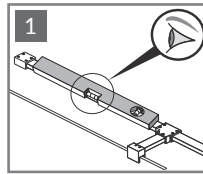
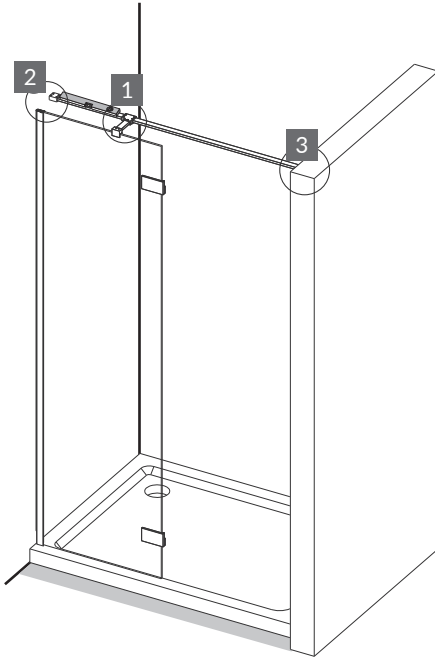
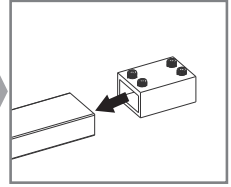
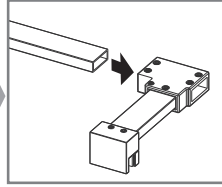
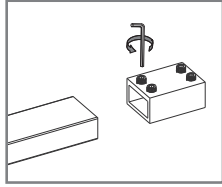
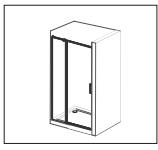

P9

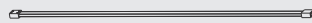

x1

P10

4X35

x4



x4

x1



11.

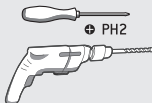
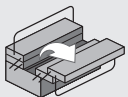
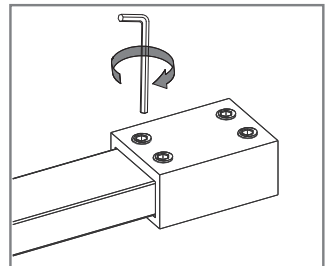
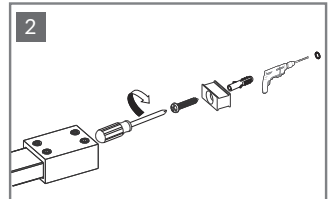
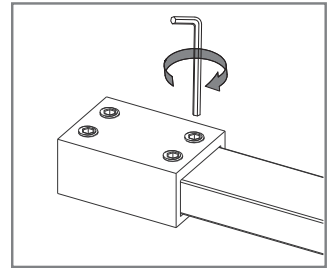
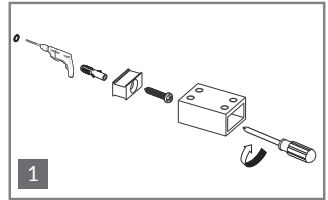
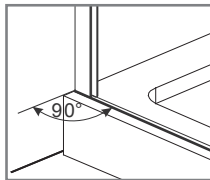
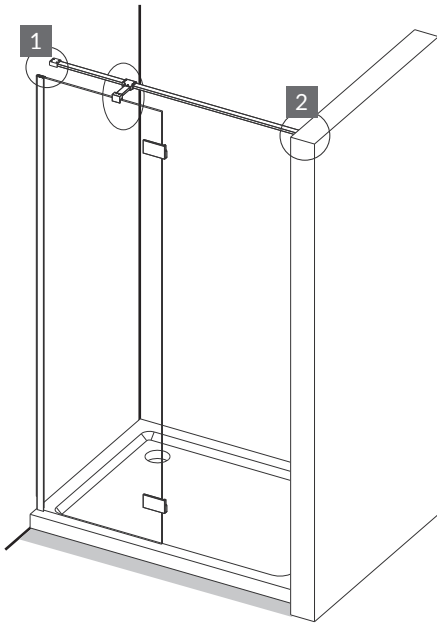
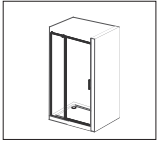

P9

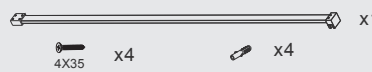

4X35 x4

x4



12.

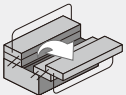
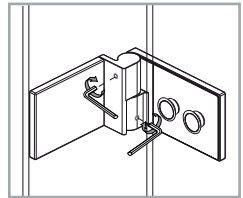
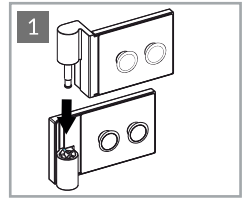
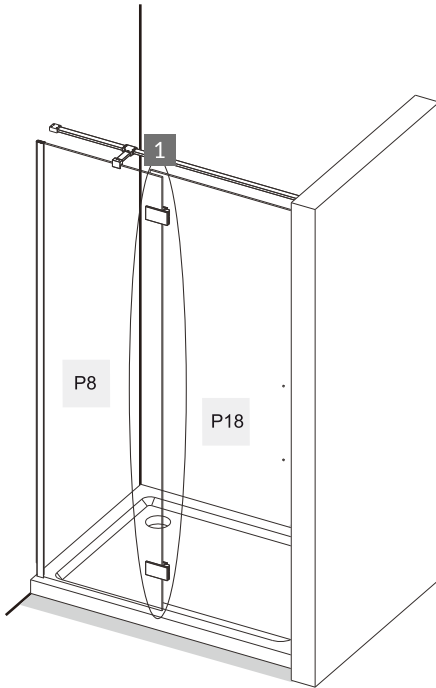





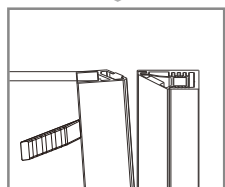
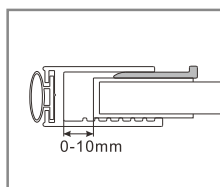
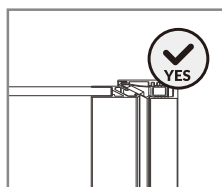
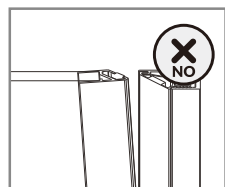
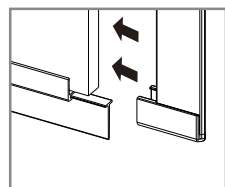
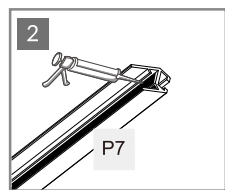
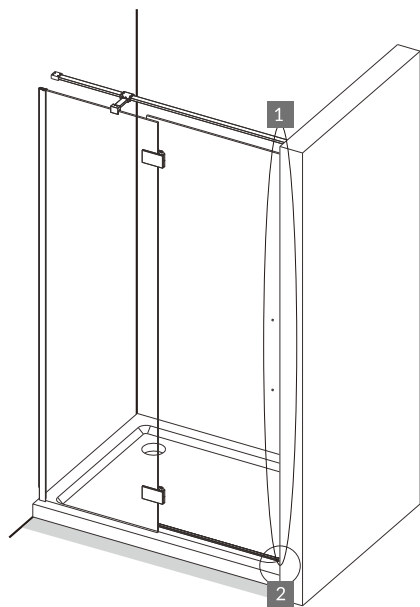
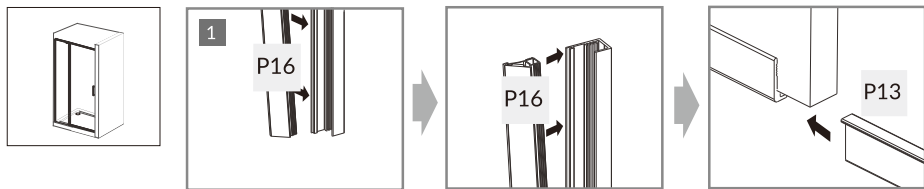

N  x1

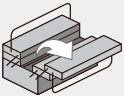
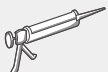

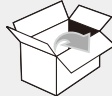
13.



		P7		x1	
		P13		x1	
		P16		x1	
		M		x1	

14.

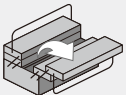
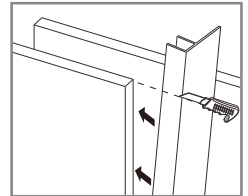
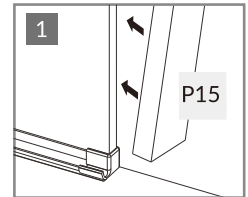
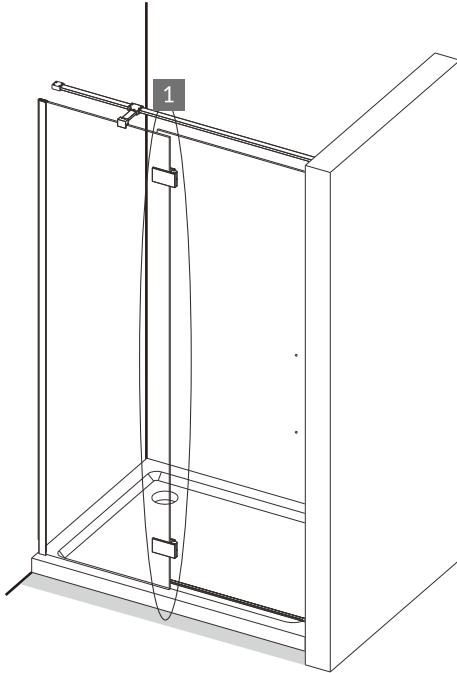
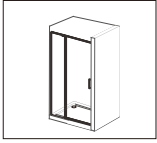

P15



x1



15.

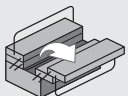
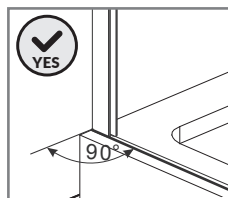
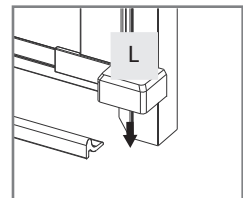
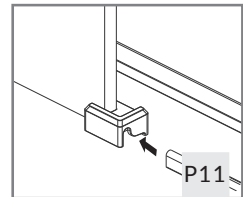
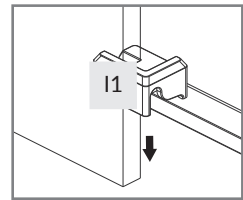
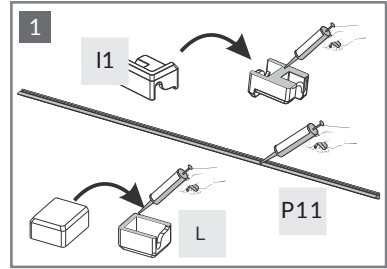
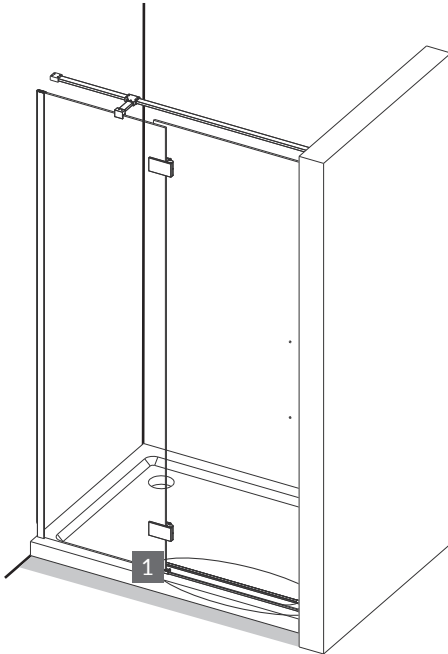
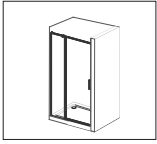

I1



x1

L



x1

P11



x1



16.

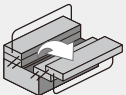
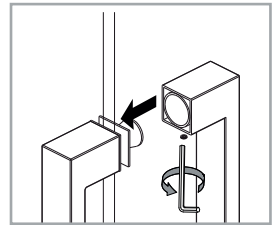
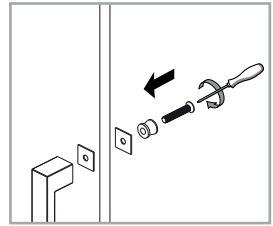
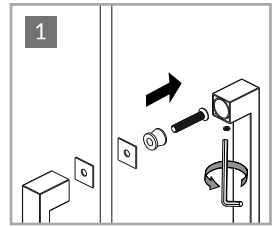
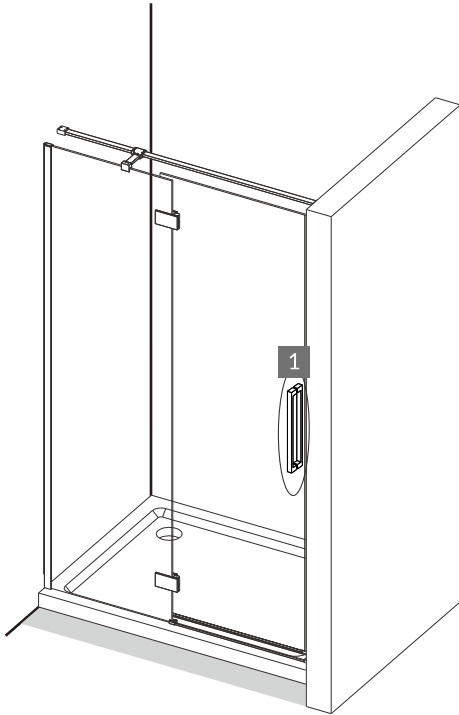
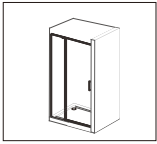

P14



x1



17.

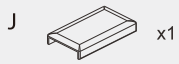
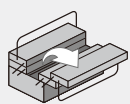
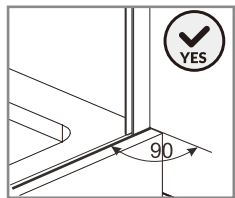
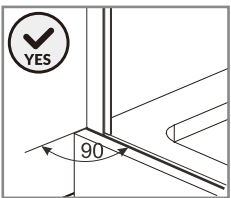
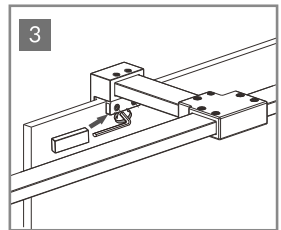
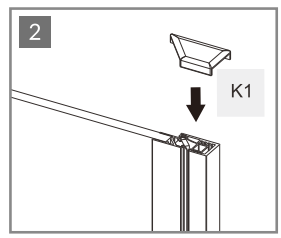
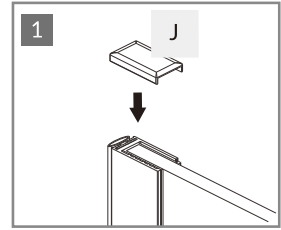
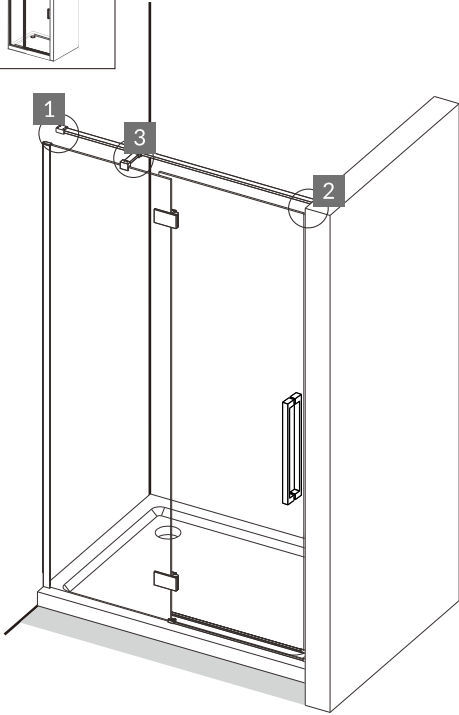
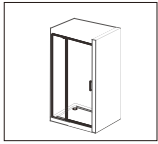

18.

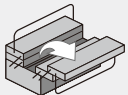
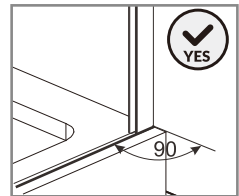
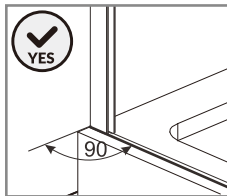
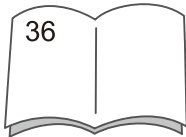
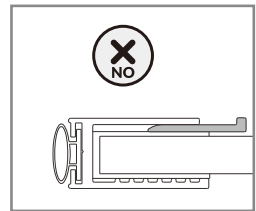
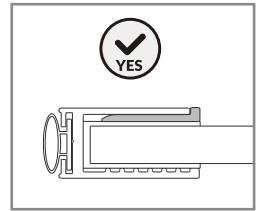
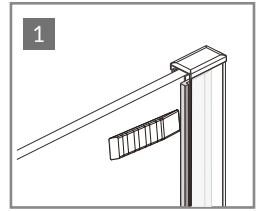
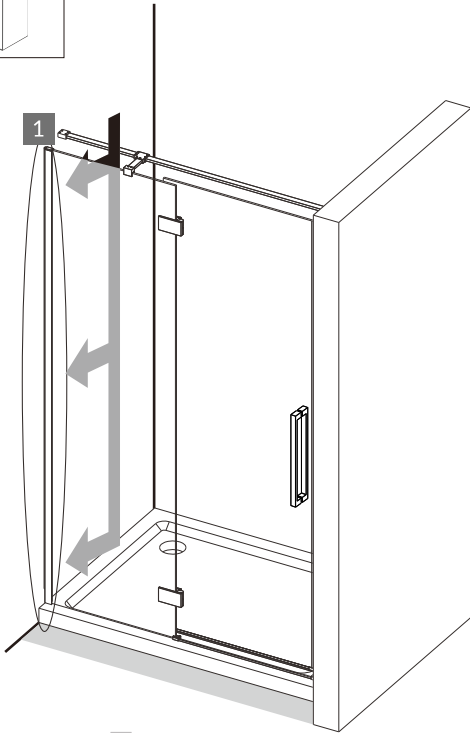
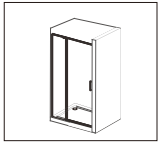

M



x1



19.

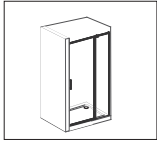

SIZE	X(mm)
900×2000	890-900
1000×2000	990-1000
1200×2000	1190-1200

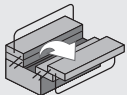
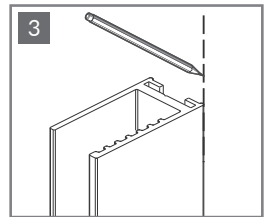
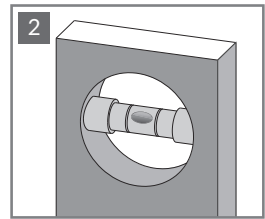
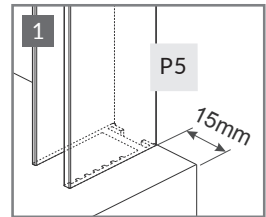
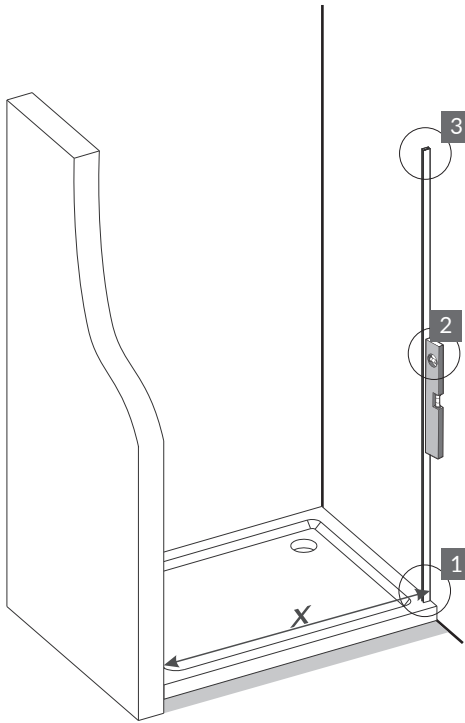

P5



x1



20.

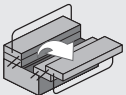
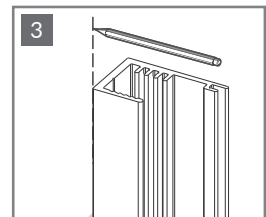
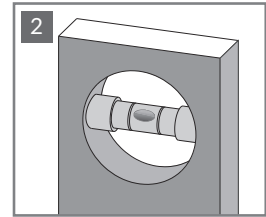
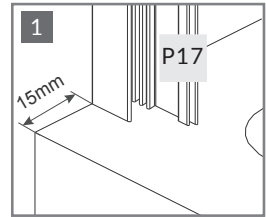
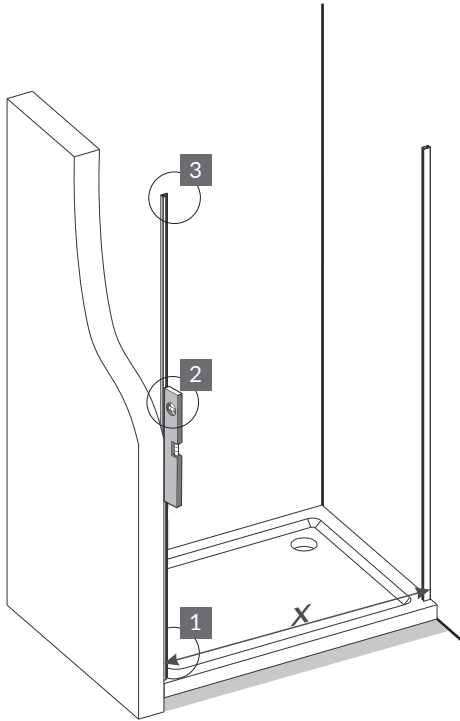
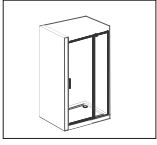

P17



x1



21.

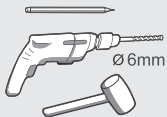
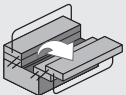
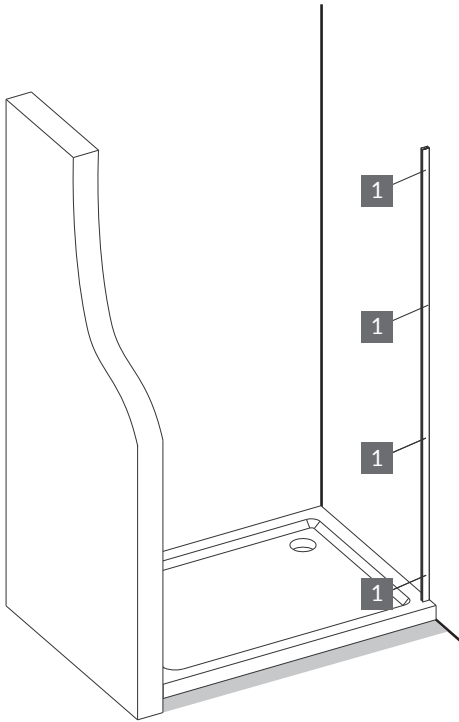
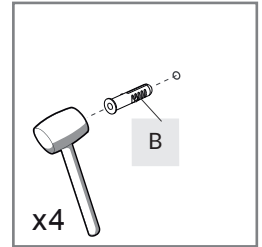
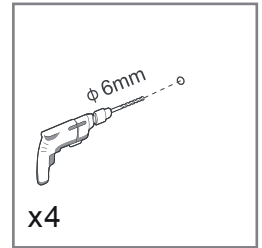
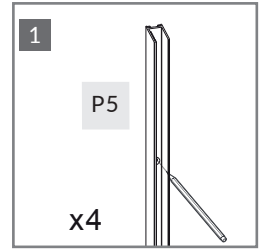
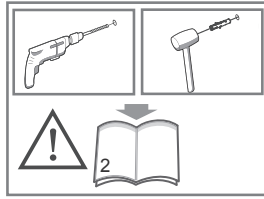
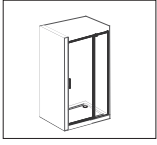

B



x4



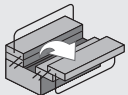
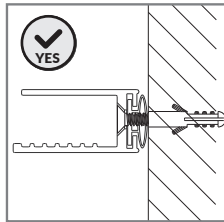
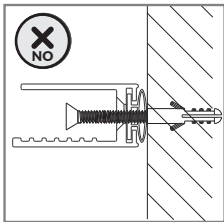
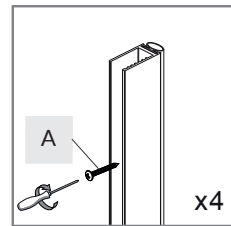
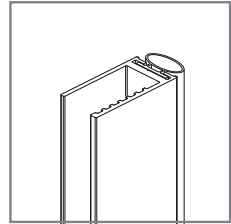
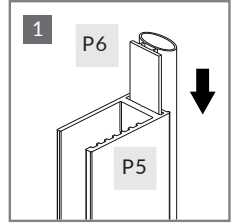
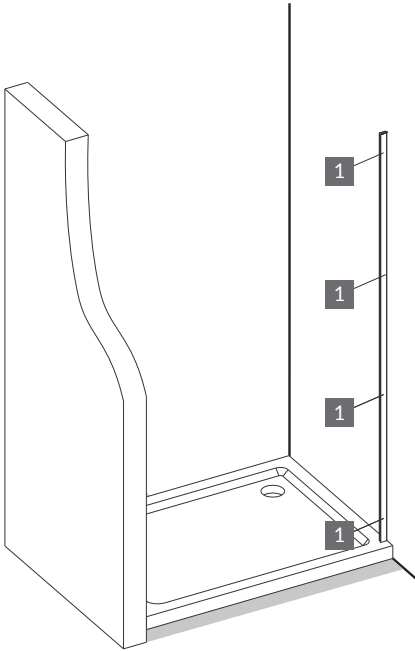
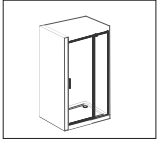

A

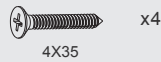

x4

P5



P6



23.

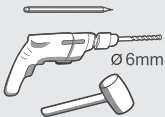
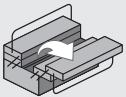
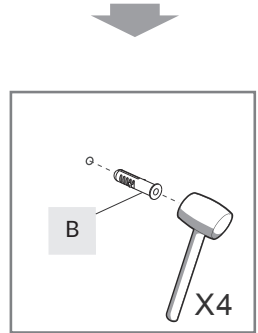
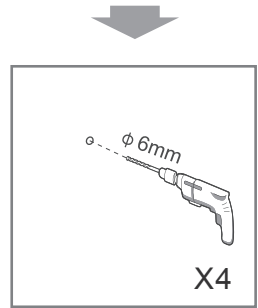
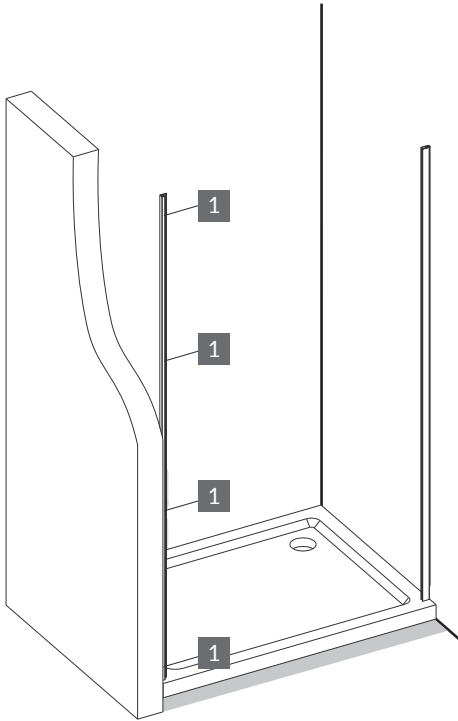
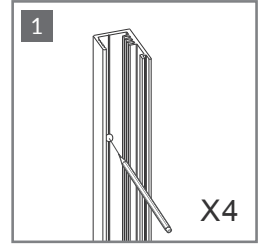
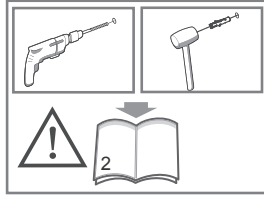
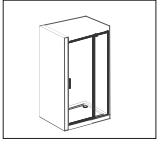

Ø 6mm

B



x4



24.

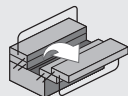
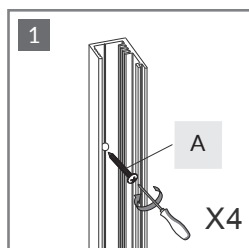
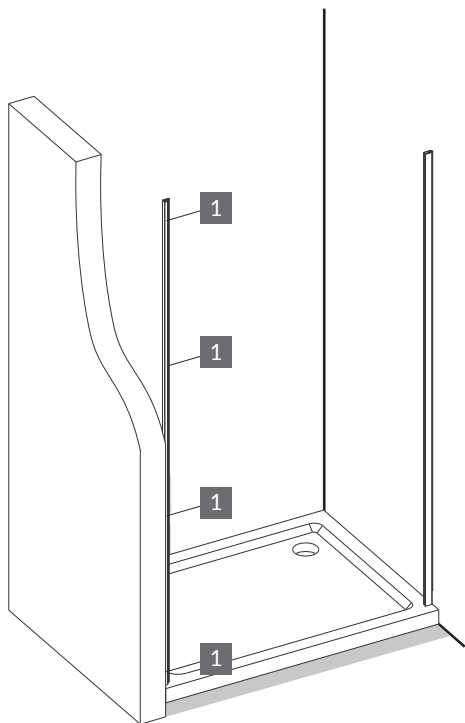

A



x4



25.

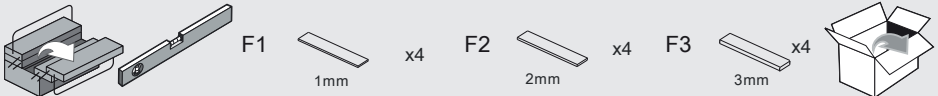
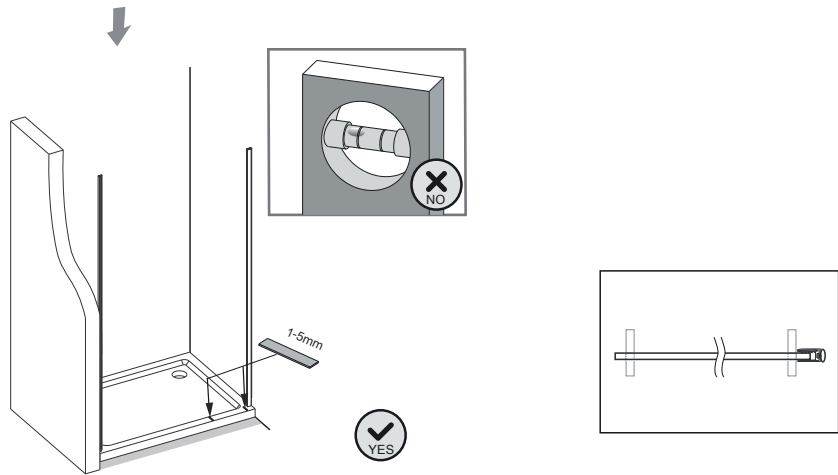
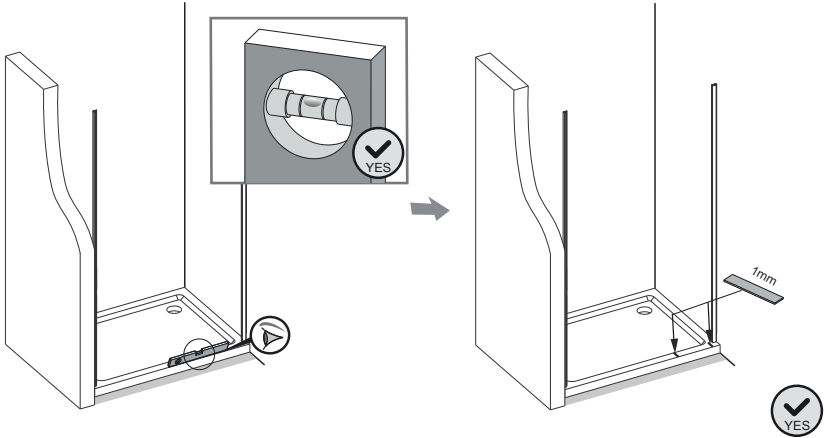
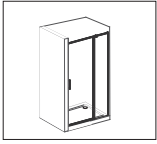

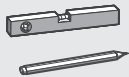
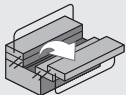
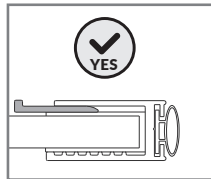
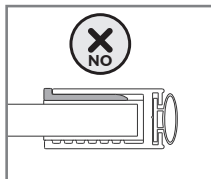
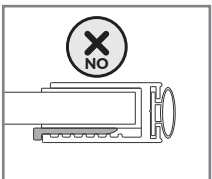
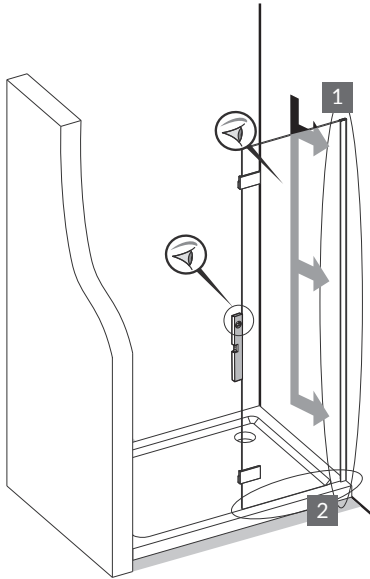
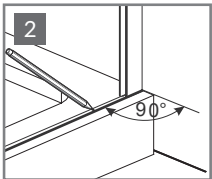
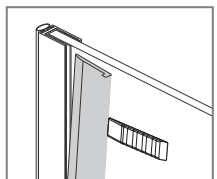
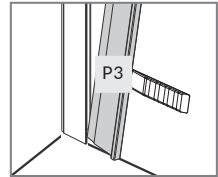
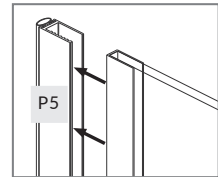
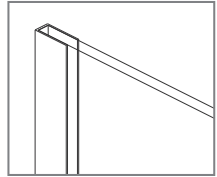
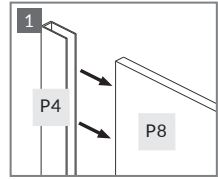
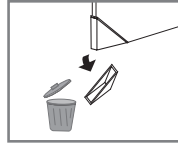
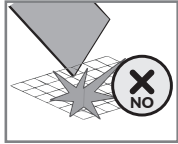
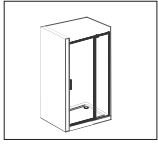

- P4 ————— x1
- P3 ————— x1
- M ————— x1



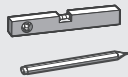
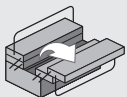
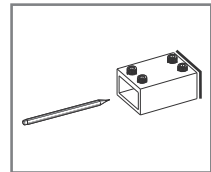
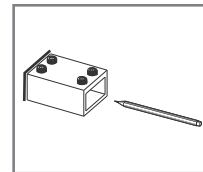
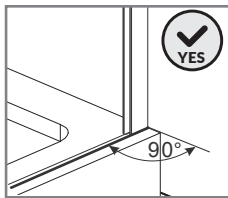
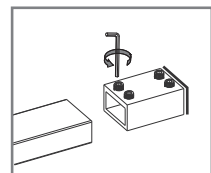
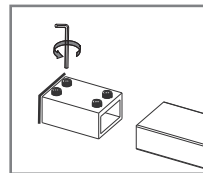
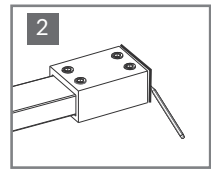
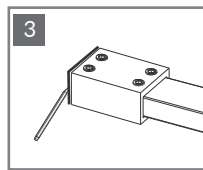
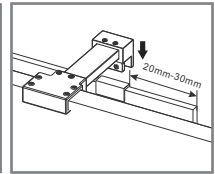
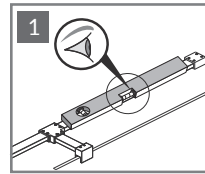
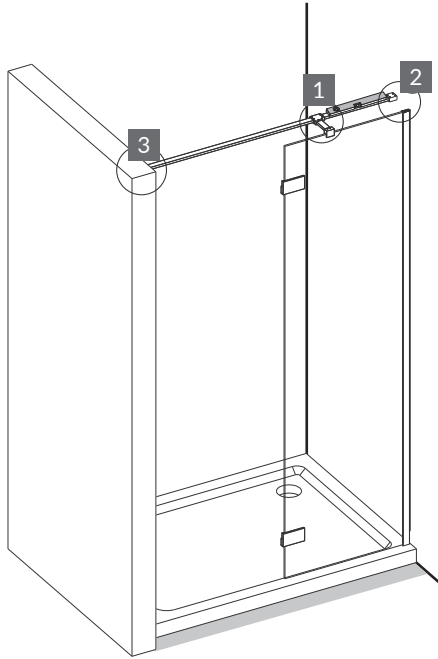
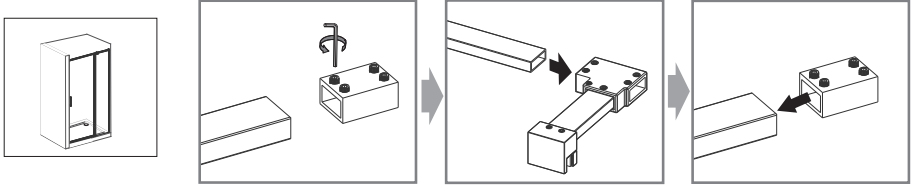

P9



x1

P10

4X35

x4



x4

x1



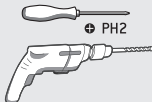
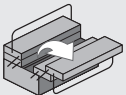
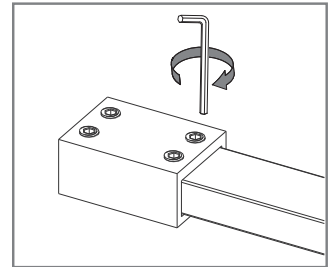
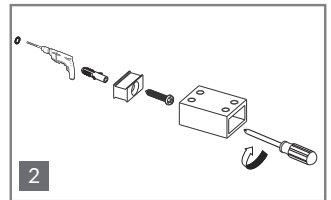
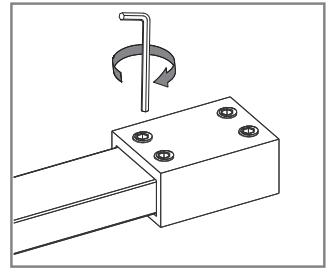
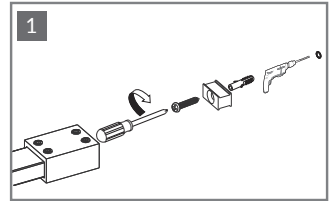
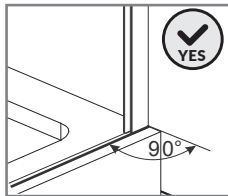
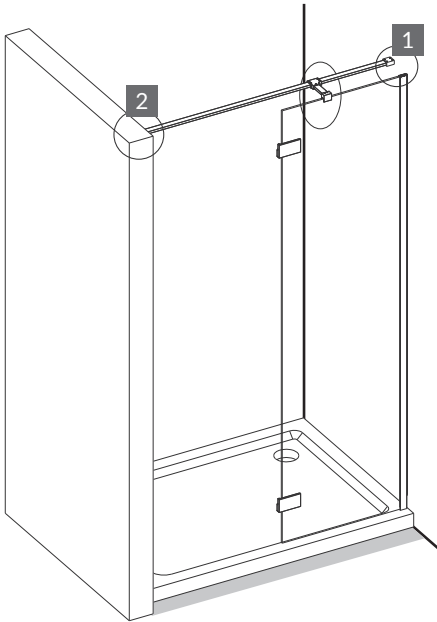
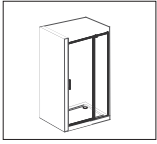

P9

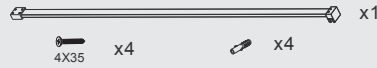

x1

4X35 x4

x4



29.

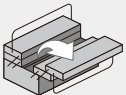
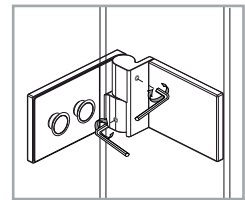
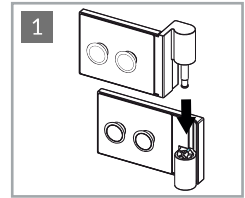
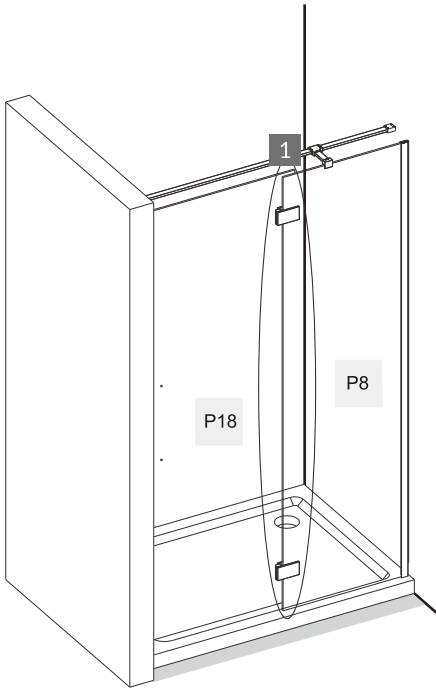
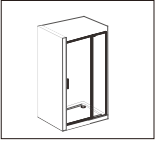

N



x1



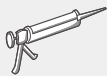
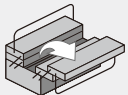
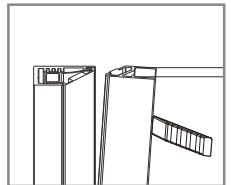
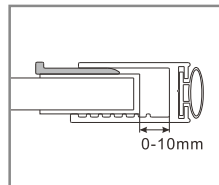
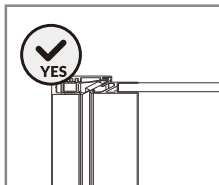
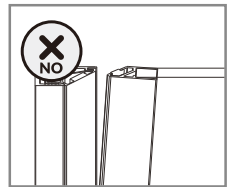
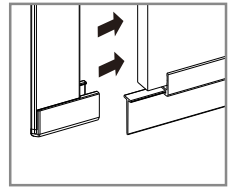
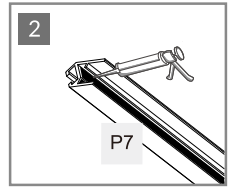
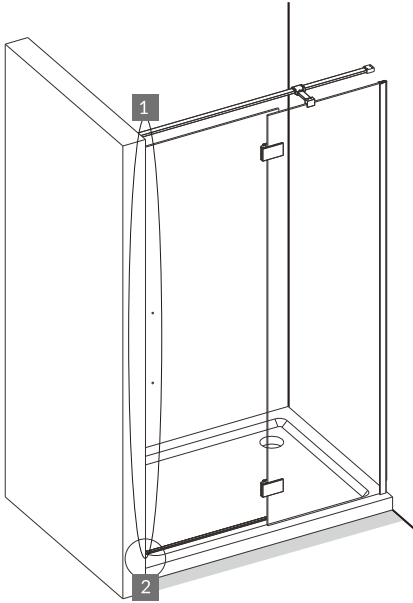
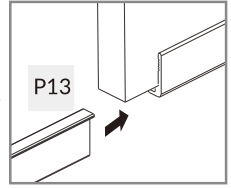
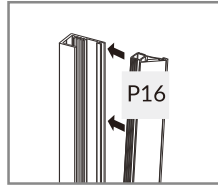
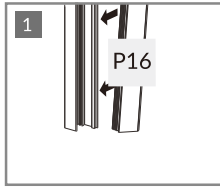
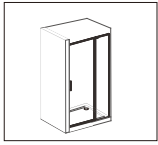

- P7 ————— x1
- P13 ————— x1
- P16 ————— x1
- M ————— x1



31.

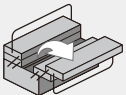
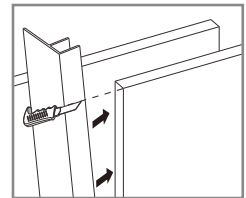
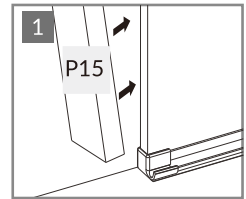
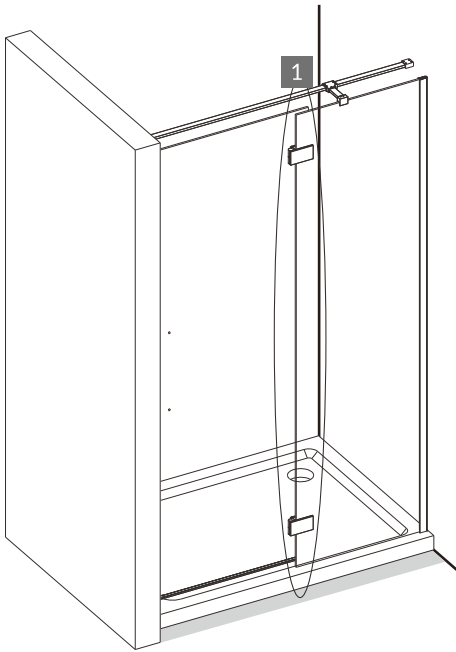
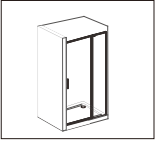

P15



x1



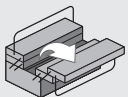
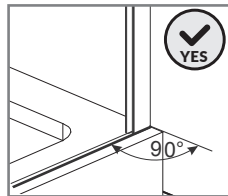
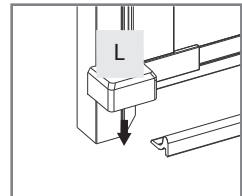
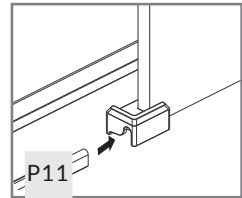
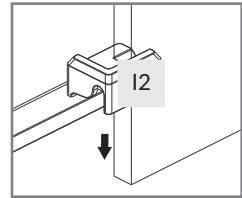
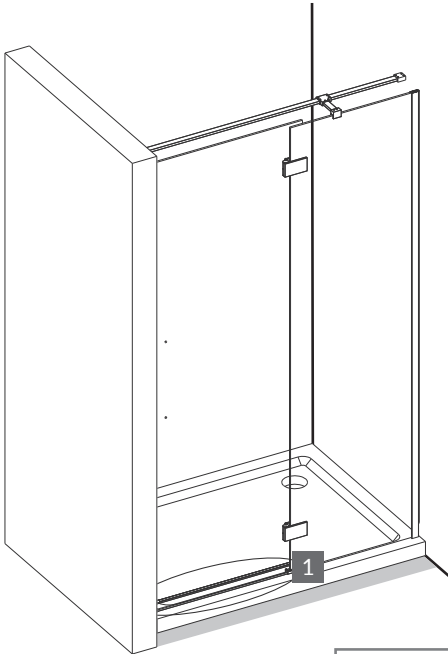
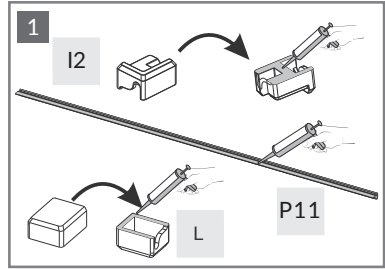
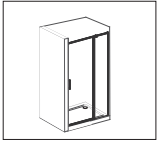

I2



x1

L



x1

P11



x1



33.

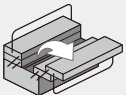
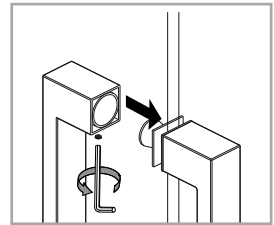
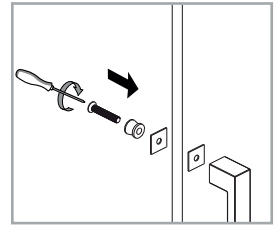
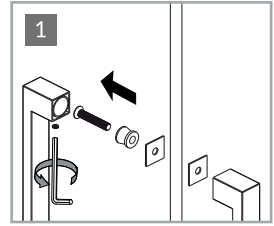
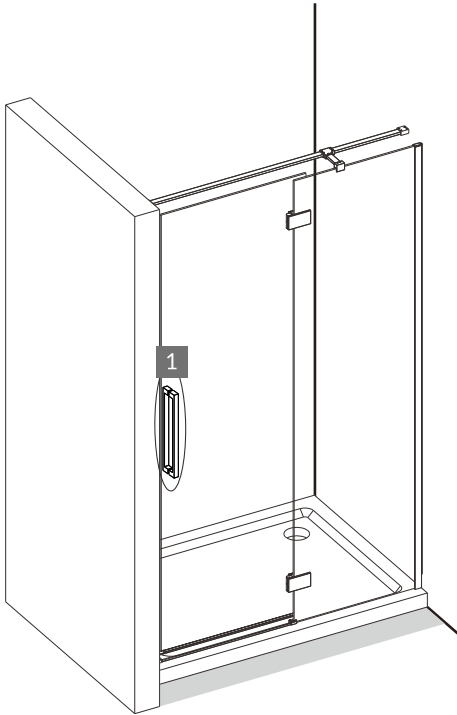
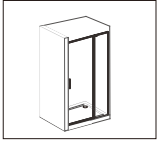

P14



x1



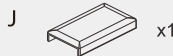
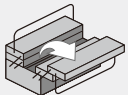
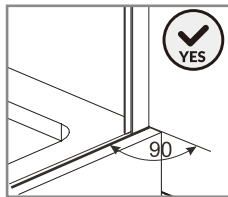
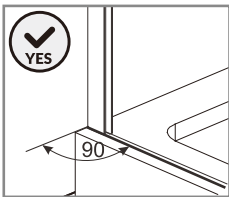
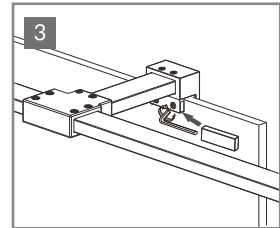
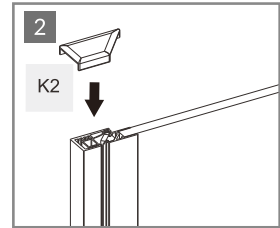
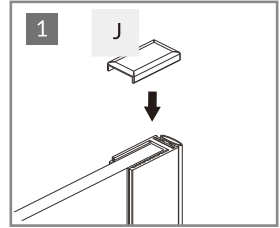
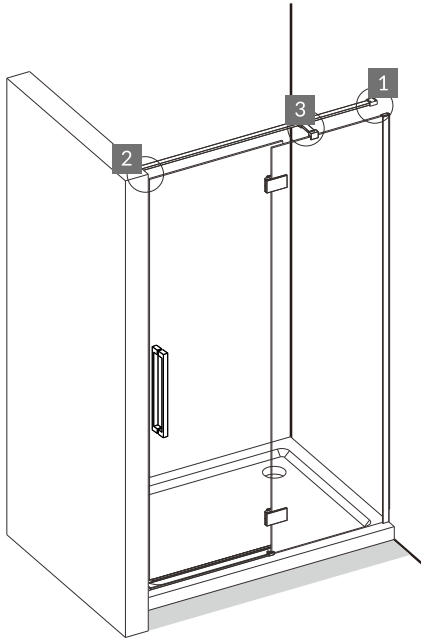
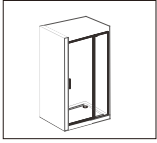

35.

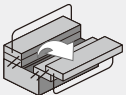
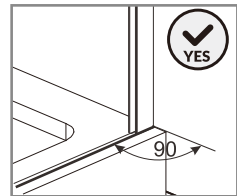
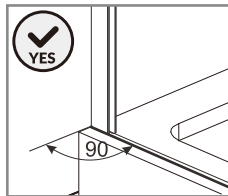
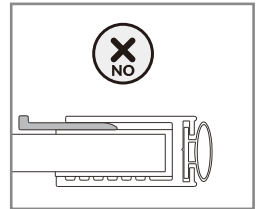
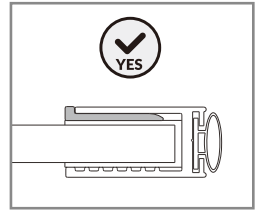
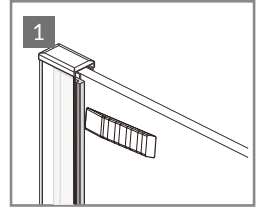
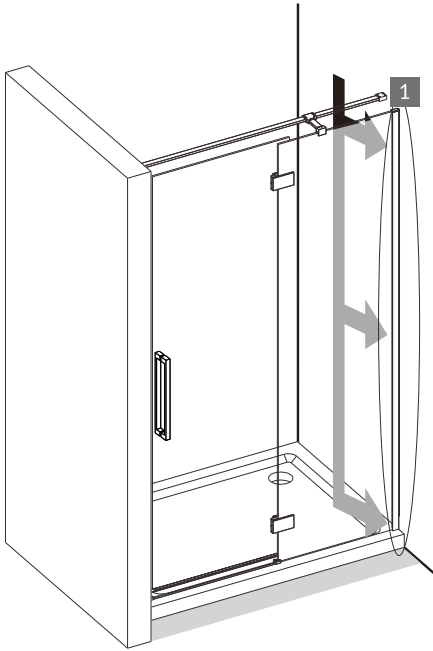
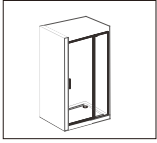

M



x1



36.

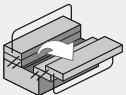
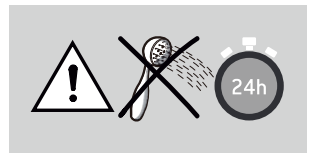
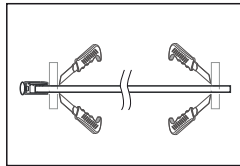
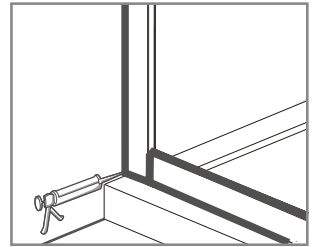
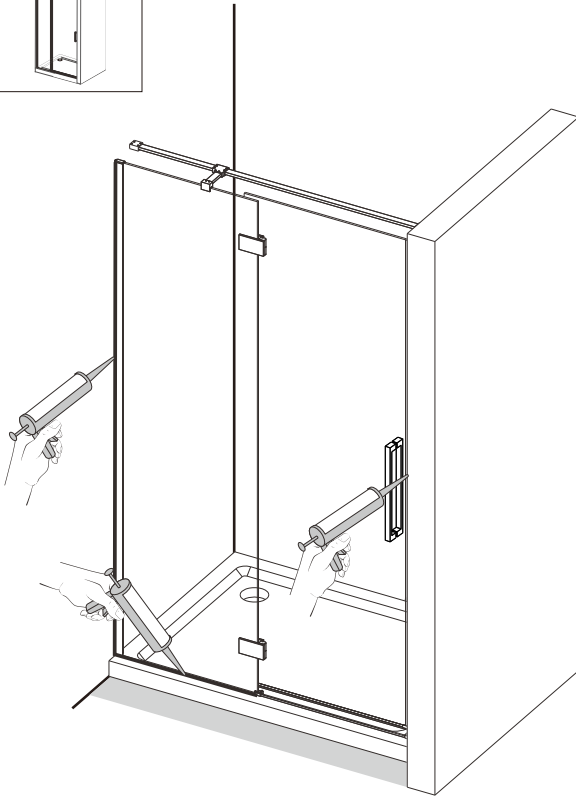



6.5 < PH < 7.5

